



# Model: EOPW1560-TR

Open Frame, 15.6" LCD Monitor, 1366x768, 300nits VGA+DVI Input with 5 Wire Resistive Touch Screen (3mm, USB) and USB Controller

## EOP Series: EOP Series: Industrial Open Frame Metal Housing LCD Monitor (Optional for High Brightness and LED Backlight)

### FEATURES HIGHLIGHTS:

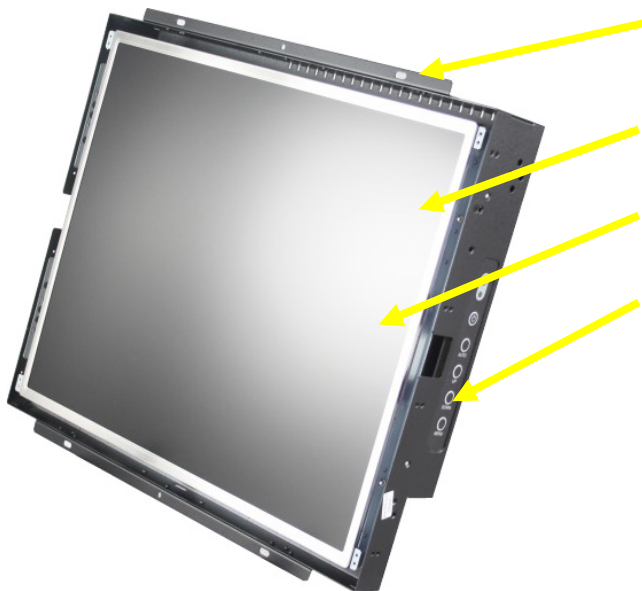

Easy to Mount Open Frame, metal chassis (top & bottom flanges)

Optional for Resistive/ Capacitive/ SAW/ IR/ Projective Capacitive Touch screen

Auto Video Signal ON / OFF  
Auto Always Power On

Side OSD buttons can prevent unnecessary setting changes.

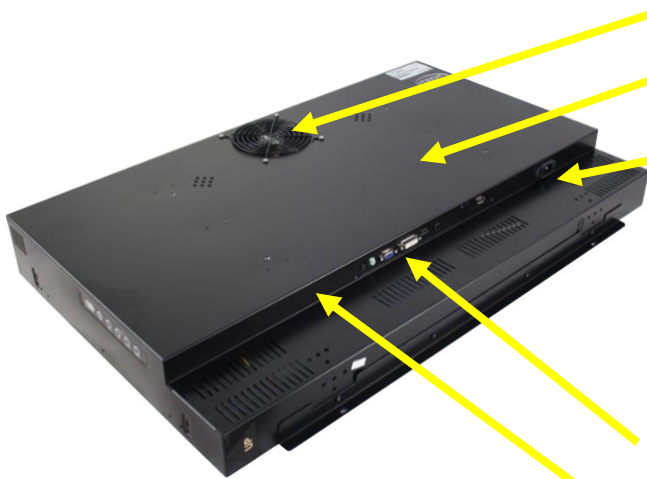

Ultra low speed/Noise fan for extra cooling (24" LCD or above)

VESA Mounting Hole Pattern

Reliable built-in Power supply for 15" or above (Optional for 9-36V DC input)



Standard VGA Input (Optional for DVI, HDMI, AV, BNC, AV looping and SDI)

Optional for RS232 Remote Control Protocol: Command Code to set system

## FEATURES:

- Modularize mechanical design provides flexible product configuration and easy maintenance.
- Optional ultra high brightness panel.
- Available with auto-brightness sensor offers application in day and night
- Optional build-in touch screen for interactive application

## SPECIFICATION:

<b>Panel</b>	Cell Type / Glass Surface	TFT LCD / Black Anti-Glare, low reflection coating	
	Aspect Ratio / Size	Wide / 15.6" viewable diagonal area	
	Active Area / Pixel Pitch	344.232(H) x 193.536(V) mm / 0.252(H) x 0.252(V) mm	
	Native Resolution / Colors	1366(H) x 768(V) / 16.7 Million	
	Brightness / Contrast	300 cd/m <sup>2</sup> (typ) / 500 :1	
	Response Time	^ 8 ms	
	Viewing Angle (typical)	H. 170° (- 85° - + 85°) , V. 160°(- 80° - + 80°)	
	Light Source	CCFL , Long life, 50,000 hrs (typ)	
<b>Input Sources</b>	PC System	Signal	Analog RGB (0.7/1.0 Vp <sub>p</sub> , 75 ohms)
		Sync	Separate Sync, Composite Sync, Sync On Green
		Frequency	F <sub>h</sub> : 30 - 82Khz, F <sub>v</sub> : 50 -75Hz
Audio System	2W speaker x 2		
<b>Input Terminals</b>	1x DVI, 1x VGA (15 Pin Female D-Sub), 1x PC Audio (Stereo Headphone Jack), 1x AC Inlet		
<b>Convenient Features</b>	Auto Calibration , Back Light Adjustment, Plug&Play (VESA DDC/CI, DDC 2B)		
	OSD Multi-Languages , Wall Mount Ready (VESA 75 x 75 mm)		
<b>Power</b>	Internal power supply with universal / Auto-Sensing, AC 90 to 260V, 50 / 60 Hz		
<b>Power Consumption</b>	Operation / Power Saving	20 watt, < 2 watt (Support DPMS)	
<b>Operating Condition</b>	Temperature / Humidity	0°C - 50°C (32°F - 122°F), 10% - 90% (no condensation)	
<b>Storage Condition</b>	Temperature / Humidity	- 20°C - 60°C (- 4°F - 140°F), 10% - 90% (no condensation)	
<b>Certification</b>	FCC,CE		
<b>Dimensions</b>	Physical	With Flanges(W x H x D): 384.4 x 252.0(screw center-to-center) x 57.0 (mm)	
		Without Flanges(W x H x D): 384.4 x 240.0 x 57.0 (mm)	
Carton	Wx H x D =TBD		
<b>Weight</b>	N.W. / G.W.	3.0 Kgs/4.0 Kgs	

<b>Options</b>	Touch	Video/TV	Enhanced Panel	Others
	Resistive touch	SV + AV	Panel with LED backlight	Digital Signage(Stand alone)
	Capacitive touch	SV + AV + AV_Looping	High brightness panel	Networking Digital Signage
	SAW touch	SV + AV + TV	Wide Temperature	Motion Sensor
	Infrared touch		Sunlight Readable	Light Sensor
	Protected glass			Auto-Dimming

## Photos (Model: EOPW1560-TR)

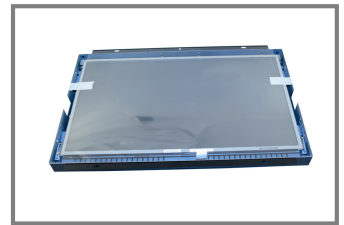
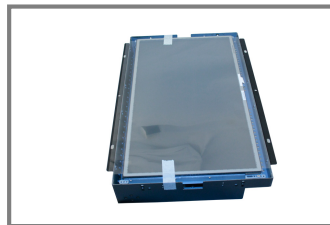

# MECHANICAL DRAWING:

This is subject to change without Notice. Final Drawings Will be Provided for Approval after Order.

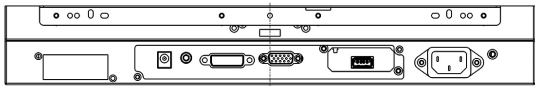
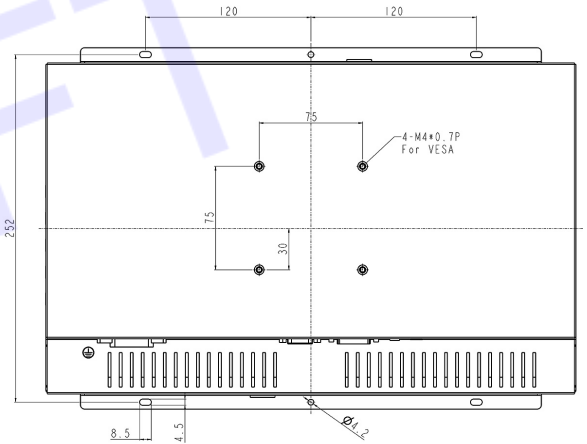
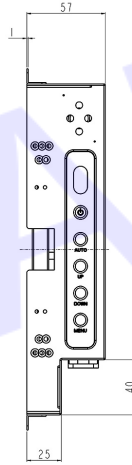
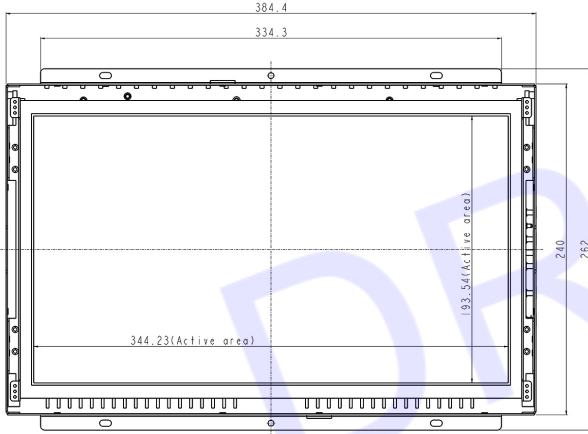
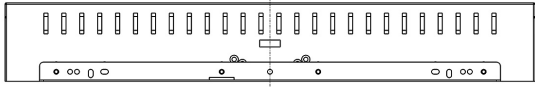

DVI Port  
VGA Port  
AC Power Input  
USB for Touch

Drawing No.: EOPW1560-TR-03142024-V1



## LCD OPTIONS:



### LED Backlight Options

Introducing LED backlight options for monitors for energy efficiency and a brighter screen.



### TouchScreen Options

Our LCD has a wide selection option to choose which touchscreen technology suits for you.

	Four-Wire Resistive	Five-Wire Resistive	Pen Touch	Capacitive	Surface Wave(Saw)	Infrared Touch (Ir)
<b>PRODUCT SIZE</b>	1.7" - 24"	10.4" - 24"	15" - 19"	12" - 24"	10.4" - 30"	10.4" - 42"
<b>TOUCH LIFE</b>	1 - 2 million touches	30 - 35million touches	100 million touches	100 million touches	50 million touches	Long-term reliability
<b>SCRATCH RESISTANCE</b>	Hard Coated	Hard Coated	Hard Coated (SiO <sub>2</sub> )	Hard Coated (SiO <sub>2</sub> )	Glass Overlay Moh's hardness rating of 7	Glass Overlay Moh's hardness rating of 7
<b>CONTAMINANT RESISTANCE</b>	Resists moisture, dirt, vinegar, ammonia based food products and cleansers	Resists moisture, dirt, vinegar, ammonia based food products and cleansers	Resists moisture, dirt, vinegar, ammonia based food products and cleansers	Resists moisture, dirt, vinegar, ammonia based food products and cleansers	Resists moisture, dirt, vinegar, ammonia based food products and cleansers	Resists moisture, dirt, vinegar, ammonia based food products and cleansers
<b>INPUT METHOD</b>	Finger, Gloved Hand, Stylus	Finger, Gloved Hand, Stylus	Stylus Pen	Finger	Finger, Gloved Hand, Soft pliable stylus	Finger, Gloved Hand, Stylus
<b>CONTROLLER</b>	USB, RS232	USB, RS232	USB, RS232	USB, RS232	USB, RS232	USB, RS232



### VIDEO Input Options:

For Video inputs options:

DVI, DVI+HDMI, SVideo+AV, SVideo+AV+DVI, AV+Looping, DVI+AV+Looping, HD-SDI, BNC (PAL/NTSC)



### Optical Bonding Options

- Optical Bonding provides the best reduction of ambient light washout of any commercially available enhancement technology.
- Optical Bonding has a lower cost than most other competing technologies.
- Optical Bonding offers superior ruggedization, enhancing the display durability under vibration, shock and other environmental extremes.



### RS-232 Remote Control Options

**Remote Control Protocol: Command Code to set system**



### 9-36V DC Input Options

iTech offers a selection of DC input from 9V to 36V



### Light Sensor and Motion Sensor Options

iTech LCD offers Light and Motion Sensor

### Privacy Filter

Front Glass Options:

- Anti Reflective AR Glass 3mm
- Anti Reflective AR Glass 6mm Vandal-Resistance
- Anti Reflective AR Glass 8mm Vandal-Resistance
- Anti Glare AG Glass 3mm