

1U Rackmount 17" LCD Keyboard Drawer w/o KVM, Native Resolution: 1280x1024, 104 key notepad keyboard with touch pad, Short depth design of 500mm (19.7") only with NB-6A

Model: NX117e



BENEFITS:

- 17" LCD console drawer featuring LED-backlit display
- Native resolution of 1280 x 1024 with support for 16.7 million colors
- Equipped with a 104-key USB keyboard available with touchpad
- Compact design with a short depth of 500mm
- Designed for easy installation by one person
- Enhanced aesthetics including a molded front handle and a two-point locking mechanism
- Comes with a standard 2-year warranty, extendable up to 5 years

OPTIONS:

- HDMI 1.4 + DVI-D + Audio in & out + Speakers (AV4.4)
- HDMI 1.4 + Speakers (HDMI)
- S-Video + Composite + Speakers (BNC)
- 3G / HD / SD-SDI Broadcast-grade input + Speakers (SDI)
- DC power : 12V / 24V / 48V / 125V / 250V
- SUN Micro keyboard option

SPECIFICATIONS

Console Port	
Video input	VGA
KB / MS	USB interface
VGA console 6ft cable: NB-6A	Drawer end : DB-15 + USB type A x 2 Server end : DB-15 + USB type A x 2

LCD Panel	
Panel size (diagonal)	17"
Native resolution	1280 x 1024
Brightness (cd/m ²)	250
Contrast ratio (typ.)	1000 : 1
Colors	16.7 M
Viewing angle (L/R/U/D)	85/85/80/80
Response time (ms)	5
Dot pitch (mm)	0.264
Display area (mm)	337.92H x 270.33V
Surface treatment	Haze 25%, Hard-coating
Surface hardness	3H
Backlight type	LED
MTBF (hrs)	30,000

Physical		
Product (W x D x H)	Single console	442 x 500 x 44 mm 17.4 x 19.7 x 1.73 inch
	Console w/ KVM	442 x 620 x 44 mm 17.4 x 24.4 x 1.73 inch
Packing (W x D x H)	Single console / Console w/ KVM	590 x 808 x 140mm 23.2 x 31.8 x 5.5inch
	Net weight	Single console 12.3 kg / 27.1 lb Console w/ KVM 13.3 kg / 29.2 lb
Gross weight	Single console	16.8 kg / 37 lb
	Console w/ KVM	18.2 kg / 40 lb

Mounting Distance	
Single console drawer	510 ~ 740 mm
Console w/ KVM drawer	20.1 ~ 29.1 inch
Console w/ KVM drawer	510 ~ 840 mm
	20.1 ~ 33.1 inch

Video Option		
Digital	DVI	DVI-D single link
	HDMI	HDMI 1.4 / HDCP 1.4
Analog	S-Video (4-pin)	NTSC & PAL
	Composite (BNC)	NTSC & PAL

HDMI

NX117 chassis extension in depth to 520mm (20.5")

S-Video & Composite

NX117 chassis extension in depth to 570mm (22.4")

Audio Option		
Input	Connector	3.5mm stereo jack
	Impedance / Power level	30kQ / 750mV
Output	Connector	3.5mm stereo jack
	Resistance / Power level	30kQ / 2.8V
Speaker	Dual stereo	2W x 2

Power		
Input	Auto-sensing 100 to 240VAC, 50 / 60Hz	
Consumption (console / KVM)	Screen on	Max. 22W / Max. 55W
	Power saving mode	Max. 2W / Max. 34W
	Power button off	Max. 1W / Nil

Environment	
Operating temp.	0 to 55°C degree
Storage temp.	-20 to 60°C degree
Operating humidity	10~90%, non-condensing
Storage humidity	5 ~90%, non-condensing
Operating altitude	16,000 ft
Non-operating altitude	40,000 ft
Shock	10G acceleration (11ms duration)
Vibration	10~300Hz 0.5G RMS random vibration

Compliance	
EMC	FCC & CE
Safety	CE / LVD & UKCA
Environment	RoHS3 & REACH / WEEE

MODELS with KVM

2K KVM	IP	Remote	8-port	
	0	0	NX117-D8	

2K KVM Cable



NK6D (6 ft)
DVI-D KVM cable



NK6H (6 ft)
HDMI KVM cable

Resolution Support **: 16:9 - max. 2560 x 1440
16:10 - max. 1920 x 1200
4:3 - max. 1600 x 1200

DVI-D KVM	IP	Remote	12-port	
	0	0	NX117-D12	

DVI-D USB KVM Cable

Resolution Support **: 16:10 - max. 1920 x 1200
16:9 - max. 1920 x 1080
4:3 - max. 1600 x 1200



NI - 6 (6 ft)
NI - 15 (15 ft)

Matrix CAT6 KVM	IP	Remote	8-port	16-port	32-port
	1	1	-	NX117-MC1116	NX117-MC1132
	2	1	-	NX117-MC2116	NX117-MC3224
	0	1	-	NX117-MC0116	NX117-MC0132
	0	2	-	NX117-MC0216	NX117-MC0232
	0	3	-	NX117-MC0316	NX117-MC0332

CAT6 KVM Dongle



USB-C dongle



IF-DUSBP
DP - USB dongle



IF-DUSBH
HDMI - USB dongle



IF-DUSBD
DVI - USB dongle



IF-DUSB
VGA - USB dongle

Resolution Support **: 16:10 - max. 1920 x 1200
16:9 - max. 1920 x 1080
4:3 - max. 1600 x 1200

CAT6 Combo KVM	IP	Remote	8-port	16-port	32-port
	1	0	NX117-CIP8	NX117-CIP16	NX117-CIP32
	0	1	NX117-CCE8	NX117-CCE16	NX117-CCE32
0	0	NX117-C8	NX117-C16	NX117-C32	

Matrix DB-15 KVM	IP	Remote	8-port	16-port
	1	1	NX117-M118	NX117-M1116
	2	1	NX117-M218	NX117-M2116
	0	1	NX117-M018	NX117-M0116
	0	2	NX117-M028	NX117-M0216
	0	3	NX117-M038	NX117-M0316

DB-15 VGA USB KVM Cable



NB - 6 (6 ft)



NB - 10 (10 ft)





NB - 15 (15 ft)

Resolution Support **: 16:10 - max. 1920 x 1200
16:9 - max. 1920 x 1080
4:3 - max. 1600 x 1200

Combo DB-15 KVM	IP	Remote	8-port	16-port
	1	0	NX117-IP8	NX117-IP16
	0	1	NX117-CE8	NX117-CE8
0	0	NX117-S8	NX117-S16	

IP Console







High Performance KVM Access Over IP

Connector : RJ45
 User management: 1 x active user, 15-user login
 Network protocol: DHCP / BOOTP / DNS
 Security : TLS 1.3, AES, LDAP, Active Directory (AD), HTTP(s)
 Browser : Chrome, Firefox, Edge, etc.
 Resolution : 16:9 - max. 1920x1080 / 16:10 - max. 1920x1200 / 4:3 - max. 1600x1200

STANDARD KEYBOARD

Ge G keyboard with touchpad

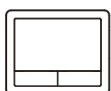
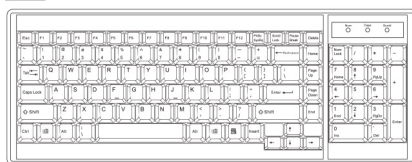

Gb G keyboard with trackball



Supporting layouts

America		U.S.
EMEA		U.K.
		Germany
		France
		Russia
		Spain
		Italy
Asia		Japan
		Korea

KEYBOARD OPTIONS *US Layout only

Se S keyboard with touchpad

Sb S keyboard with trackball



STRUCTURE DIAGRAM

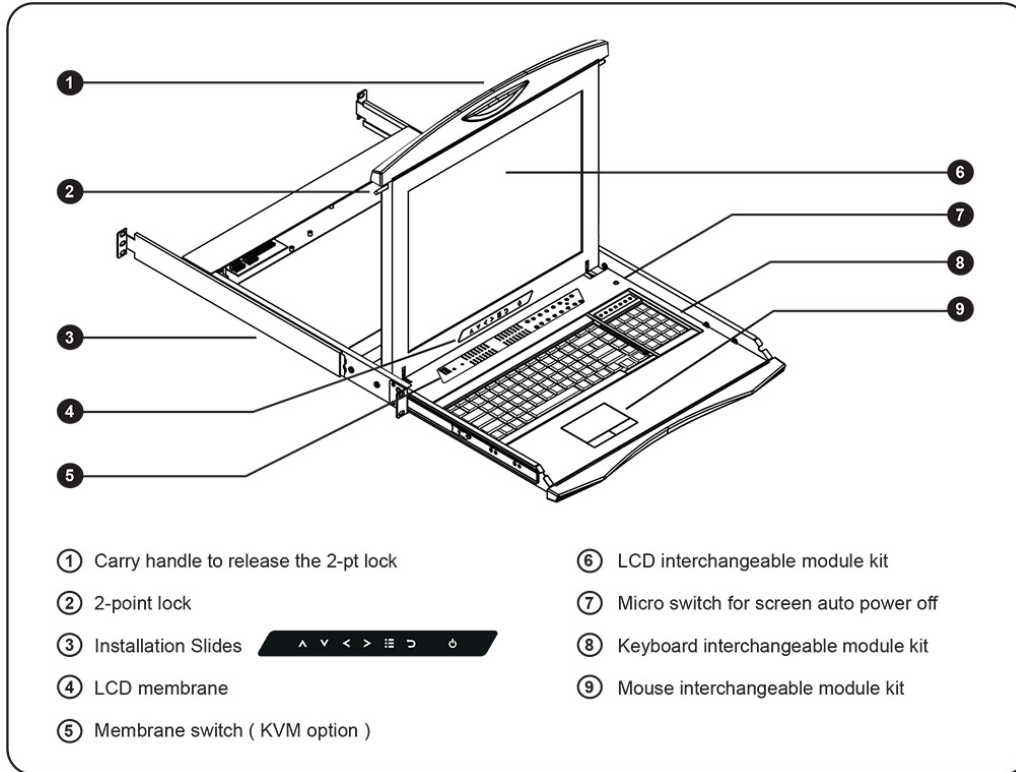

DIMENSION

This is subject to change without Notice. Final Drawings Will be Provided for Approval after Order.

Front View

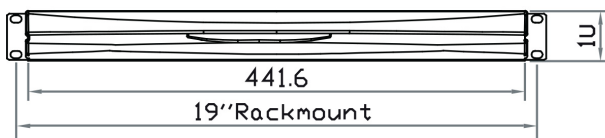

Rear View



Side View

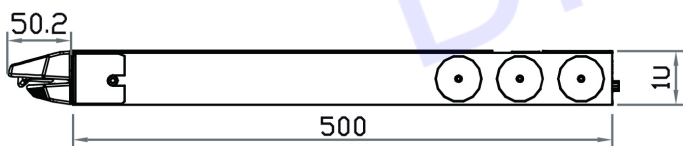

Top View

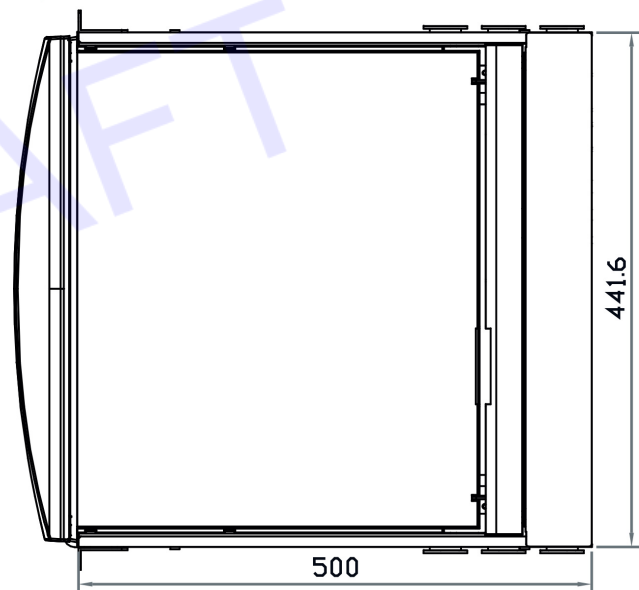

Drawing No.: NX117e-02012024-V1