

1U 17" Ultra Short Depth FHD LCD Console Drawer
1920x1080 with 8-Ports 2K HDMI USB KVM, 104 key keyboard
w/ touchpad

Model: NW1417HD-8Ke



FEATURES:

- 1U 17" LCD console drawer
- Front USB hub port for device access
- 1920 x 1080 native resolution / 16.7M colors (8-bit)
- Ideal for open rack / short depth rack
- 104-key keyboard with either touchpad or trackball
- One Man installation design
- Enhanced aesthetics with new molded front panel and 2-point lock
- 2-year standard warranty (upgradable up to 5 years)

SPECIFICATIONS:

| LCD Panel | |
|----------------------------------|--------------------------|
| Panel size (diagonal) | 17.3" |
| Native resolution | 1920 x 1080 |
| Brightness (cd/m ²) | 300 |
| Contrast ratio (typ.) | 1000 : 1 |
| Colors | 16.7 M, 8-bit |
| Viewing angle (L/R/U/D) | 89/89/89/89 |
| Response time (ms) | 25 |
| Dot pitch (mm) | 0.1989 |
| Display area (mm) | 381.888H x 214.812V |
| Surface treatment | Anti-glare, Hard-coating |
| Surface hardness | 3H |
| Backlight type | LED |
| MTBF (hrs) | 15,000 |

| Mounting Distance | |
|-----------------------|----------------------------------|
| Console w/ KVM drawer | 410 ~ 760 mm 16.1 ~ 29.9 inch |

| Video Option | | |
|--------------|-------------------|---------------------|
| Digital | HDMI | HDMI 1.4 / HDCP 1.4 |
| | Display port | DP 1.0 / HDCP 1.3 |
| Analog | Composite (BNC) | NTSC & PAL |

OPTIONS

- HDMI 1.4 / DP 1.0 video input
- 3G / HD / SD-SDI Broadcast-grade input
- Composite (BNC)
- DC power : 12V / 24V / 48V / 125V
- MAC or SUN Micro keyboard options available
- Touchscreen : Resistive 1-pt

| Power | | |
|-----------------------------|-------------------|---------------------|
| Consumption (console / KVM) | Screen on | Max. 14W / Max. 45W |
| | Power saving mode | Max. 2W / Max. 34W |
| | Power button on | Max. 1W / Nil |

| Environment | |
|------------------------|------------------------------------|
| Operating temp. | 0 to 55°C degree |
| Storage temp. | -20 to 60°C degree |
| Operating humidity | 20~90%, non-condensing |
| Storage humidity | 5 ~90%, non-condensing |
| Operating altitude | 16,000 ft |
| Non-operating altitude | 40,000 ft |
| Shock | 10G acceleration (11ms duration) |
| Vibration | 10~300Hz 0.5G RMS random vibration |

| Compliance | |
|-------------|-------------------------|
| EMC | FCC & CE certified |
| Safety | CE / LVD certified |
| Environment | RoHS2 & REACH compliant |

| Physical | | |
|------------------------------|--------------------------|--|
| Dimensions: (W x D x H) | Console w/ KVM | 442 x 540 x 44 mm 17.4 x 21.3 x 1.73 inch |
| | Packing (W x D x H) | 590 x 622 x 140 mm 23.2 x 24.5 x 5.5 inch |
| Net weight | Console w/ KVM | 10.4 kg / 22.9 lb |
| Gross weight | Console w/ KVM | 16.3 kg / 35.9 lb |

***Specifications subject to change without notice, not responsible for typographical errors.**

2K HDMI KVM

| | | | |
|---------------|-----------|---------------|---------------|
| 2K KVM | IP | Remote | 8-port |
| | 0 | 0 | NW1417HD-8K |

2K KVM Cable



N2K-6D (6 ft) **N2K-6H (6 ft)**
 DVI-D KVM cable HDMI KVM cable
 6ft 2K 60Hz 6ft 2K 60Hz

Resolution 16:9 - max. 2560 x 1440
 Support **: 16:10 - max. 1920 x 1200
 4:3 - max. 1600 x 1200

| Local Console | |
|--------------------|--|
| Keyboard / Mouse : | 2 x USB-A |
| Video : | 1 x HDMI 1.4 |
| Resolution : | 16 : 9 - max. 2560 x 1440@60Hz 16 : 10 - max. 1920 x 1200@60Hz 4 : 3 - max. 1600 x 1200@60Hz |

KVM FEATURES

- 2K KVM with 8 HDMI USB ports in 1U
- 2K KVM cables support DP & HDMI video input
- Local console & KVM ports support resolution 2K and 1080p.
- Multi-platform for PC, server, blade server & SUN / MAC
- Port switching via front button & keyboard hotkeys
- Hot pluggable, no software or drivers required

OPTIONS

DC power options: 12V / 24V / 48V / 125V

| KVM Port | |
|--------------|--|
| Port # : | 8 |
| Connector : | HDMI 1.4 + USB-B (Video + KB / MS) |
| Resolution : | 16 : 9 - max. 2560 x 1440@60Hz 16 : 10 - max. 1920 x 1200@60Hz 4 : 3 - max. 1600 x 1200@60Hz |

LOCAL CONSOLE & KVM PORT CONNECTION

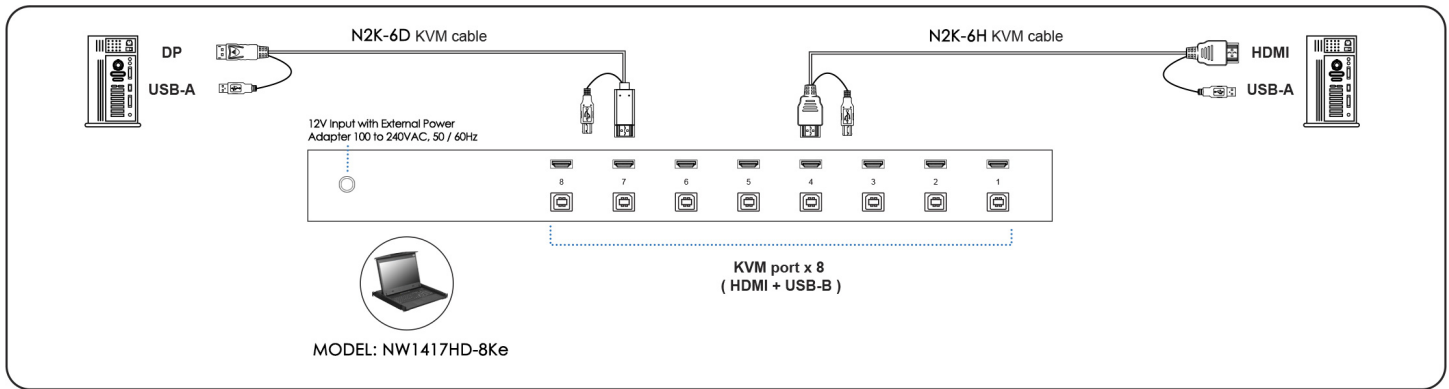

| Management | |
|------------------------|---|
| Port switching | Front button & keyboard hotkeys |
| Compatibility | |
| Hardware | HP / IBM / Dell PC, Server and Blade Server SUN / Mac |
| OS support | Windows / Linux / Unix / Mac OS |
| Environment | |
| Operating temp. | 0 to 55°C degree |
| Storage temp. | -20 to 60°C degree |
| Operating humidity | 20~90%, non-condensing |
| Operating altitude | 16,000 ft |
| Non-operating altitude | 40,000 ft |
| Shock | 10G acceleration (11ms duration) |
| Vibration | 10~300Hz 0.5G RMS random vibration |

| Power | |
|-------------|---------------------------------------|
| Input | Auto-sensing 100 to 240VAC, 50 / 60Hz |
| Consumption | Max. 10W |
| Compliance | |
| Safety | FCC & CE certified |
| Environment | RoHS2 & REACH compliant |

STANDARD KEYBOARD



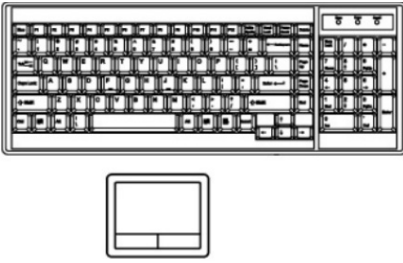



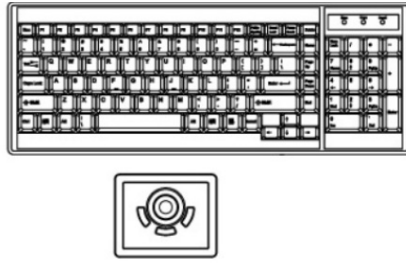

e keyboard integrated with touchpad



b keyboard integrated with trackball



Supporting layouts

| | | | | | |
|---------|---|---|---|---|---|
| America |  | | | | |
| | United States | | | | |
| EMEA |  |  |  |  |  |
| | United Kingdom | Germany | France | Spain | Italy |
| Asia |  |  | | | |
| | Japan | Korea | | | |

KEYBOARD OPTIONS (US layout only)

Me Mac keyboard with touchpad



Mb Mac keyboard with trackball

Se S keyboard with touchpad

Sb S keyboard with trackball

