

1U Rackmount 19" TFT LCD Monitor, 1920x1080 native resolution, DVI-D + VGA video input / USB KB / MS, 104-key keyboard with touchpad Include CV-6A: DVI-D console and USB x 2 (Keyboard and mouse) cable, 6 ft long

Model: NW119HDe



BENEFITS:

- 1U 19" FHD LCD console drawer
- 1920 x 1080 native resolution / 16.7M colors
- DVI-D + VGA video input / USB KB / MS
- 104-key keyboard with either touchpad or trackball
- Short depth design of 460mm
- One Man installation design
- Enhanced aesthetics with new molded front panel and 2-point lock
- 2-year standard warranty (upgradable up to 5 years)

SPECIFICATIONS

Console Port	
Video input	VGA + DVI-D single link
KB / MS	USB interface
VGA console 6ft cable : NB-6A or	Drawer end : DB-15 + USB type A x 2 Server end : DB-15 + USB type A x 2
DVI-D console 6ft cable : CV-6A	Drawer end : DVI-D + USB type A x 2 Server end : DVI-D + USB type A x 2

LCD Panel	
Panel size (diagonal)	18.5"
Native resolution	1920 x 1080
Brightness (cd/m ²)	350
Contrast ratio (typ.)	1000 : 1
Colors	16.7 M
Viewing angle (L/R/U/D)	89/89/89/89
Response time (ms)	20
Dot pitch (mm)	0.213
Display area (mm)	408.98H x 230.04V
Surface treatment	Anti-glare, Hard-coating
Surface hardness	3H
Backlight type	LED
MTBF (hrs)	50,000

Physical		
Product (WxDxH)	Single console	442 x 460 x 44 mm 17.4 x 18.1 x 1.73 inch
	Console w/ KVM	442 x 580 x 44 mm 17.4 x 22.8 x 1.73 inch
Packing (WxDxH)	Single console / Console w/ KVM	590 x 808 x 140 mm 23.2 x 31.8 x 5.5 inch
	Net weight	Single console 11.5 kg / 25.3 lb
Gross weight	Console w/ KVM	12.5 kg / 28 lb
	Single console	16 kg / 35.2 lb
Console w/ KVM	Single console	16 kg / 35.2 lb
	Console w/ KVM	18.1 kg / 39.8 lb

Mounting Distance	
Single console drawer	470 ~ 700 mm 18.5 ~ 27.6 inch
Console w/ KVM drawer	470 ~ 800 mm 18.5 ~ 31.5 inch

OPTIONS:

- HDMI 1.4 + Audio input & output (AV4.4)
- HDMI 1.4 video input (HDMI)
- DP 1.0 video input * (DP)
- 3G / HD / SD-SDI Broadcast-grade input (SDI)
- Composite (BNC)
- DC power : 12V / 24V / 48V / 125V
- MAC or SUN Micro keyboard options available

*No DVI-D after integration of DP 1.0 video input

Video Option		
Digital	HDMI	HDMI 1.4 / HDCP 1.4
	Display port	DP 1.0 / HDCP 1.3
Analog	Composite (BNC)	NTSC & PAL

Audio Option		
Input	Connector	3.5mm stereo jack
	Impedance / Power level	30kQ / 750mV
Output	Connector	3.5mm stereo jack
	Resistance / Power level	30kQ / 2.8V
Speaker	Dual stereo	2W x 2

Power		
Input	Auto-sensing 100 to 240VAC, 50 / 60Hz	
Consumption (console / KVM)	Screen on	Max. 14W / Max. 45W
	Power saving mode	Max. 2W / Max. 34W
	Power button off	Max. 1W / Nil

Environment	
Operating temp.	-20 to 70°C degree
Storage temp.	-20 to 70°C degree
Operating humidity	20~90%, non-condensing
Storage humidity	5 ~90%, non-condensing
Operating altitude	16,000 ft
Non-operating altitude	40,000 ft
Shock	10G acceleration (11ms duration)
Vibration	10~300Hz 0.5G RMS random vibration

Compliance	
EMC	FCC & CE
Safety	CE / LVD & UKCA
Environment	RoHS3 & REACH

*Specifications subject to change without notice, not responsible for typographical errors.

MODELS with KVM

2K KVM	IP	Remote	8-port	
	0	0	NW119HD-D8	

2K KVM Cable



NK6D (6 ft)
DVI-D KVM cable



NK6H (6 ft)
HDMI KVM cable

Resolution Support **: 16:9 - max. 2560 x 1440
16:10 - max. 1920 x 1200
4:3 - max. 1600 x 1200

DVI-D KVM	IP	Remote	12-port	
	0	0	NW119HD-D12	

DVI-D USB KVM Cable

Resolution Support **: 16:10 - max. 1920 x 1200
16:9 - max. 1920 x 1080
4:3 - max. 1600 x 1200



NI - 6 (6 ft)
NI - 15 (15 ft)

Matrix CAT6 KVM	IP	Remote	8-port	16-port	32-port
	1	1	-	NW119HD-MC1116	NW119HD-MC1132
	2	1	-	NW119HD-MC2116	NW119HD-MC3224
	0	1	-	NW119HD-MC0116	NW119HD-MC0132
	0	2	-	NW119HD-MC0216	NW119HD-MC0232
	0	3	-	NW119HD-MC0316	NW119HD-MC0332

CAT6 KVM Dongle



USB-C dongle



IF-DUSBP
DP - USB dongle



IF-DUSBH
HDMI - USB dongle



IF-DUSBD
DVI - USB dongle



IF-DUSB
VGA - USB dongle

Resolution Support **: 16:10 - max. 1920 x 1200
16:9 - max. 1920 x 1080
4:3 - max. 1600 x 1200

CAT6 Combo KVM	IP	Remote	8-port	16-port	32-port
	1	0	NW119HD-CIP8	NW119HD-CIP16	NW119HD-CIP32
	0	1	NW119HD-CCE8	NW119HD-CCE16	NW119HD-CCE32
	0	0	NW119HD-C8	NW119HD-C16	NW119HD-C32

Matrix DB-15 KVM	IP	Remote	8-port	16-port
	1	1	NW119HD-M118	NW119HD-M1116
	2	1	NW119HD-M218	NW119HD-M2116
	0	1	NW119HD-M018	NW119HD-M0116
	0	2	NW119HD-M028	NW119HD-M0216
	0	3	NW119HD-M038	NW119HD-M0316

DB-15 VGA USB KVM Cable



NB - 6 (6 ft)



NB - 10 (10 ft)





NB - 15 (15 ft)

Resolution Support **: 16:10 - max. 1920 x 1200
16:9 - max. 1920 x 1080
4:3 - max. 1600 x 1200

Combo DB-15 KVM	IP	Remote	8-port	16-port
	1	0	NW119HD-IP8	NW119HD-IP16
	0	1	NW119HD-CE8	NW119HD-CE8
	0	0	NW119HD-S8	NW119HD-S16

IP Console







High Performance KVM Access Over IP

Connector : RJ45
 User management: 1 x active user, 15-user login
 Network protocol: DHCP / BOOTP / DNS
 Security : TLS 1.3, AES, LDAP, Active Directory (AD), HTTP(s)
 Browser : Chrome, Firefox, Edge, etc.
 Resolution : 16:9 - max. 1920x1080 / 16:10 - max. 1920x1200 / 4:3 - max. 1600x1200

STANDARD KEYBOARD



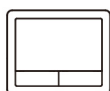
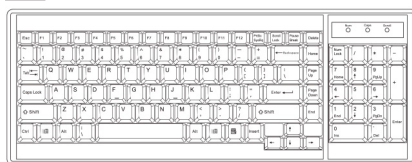



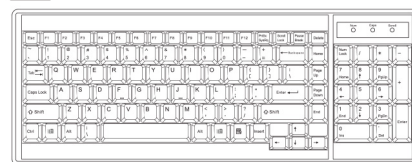

Ge G keyboard with touchpad



Gb G keyboard with trackball



Supporting layouts

America						
	U.S.					
EMEA						
	U.K.	Germany	France	Russia	Spain	Italy
Asia						
	Japan	Korea				

KEYBOARD OPTIONS

* US layout only

Me Mac keyboard with touchpad



Se S keyboard with touchpad

Mb Mac keyboard with trackball

Sb S keyboard with trackball



STRUCTURE DIAGRAM

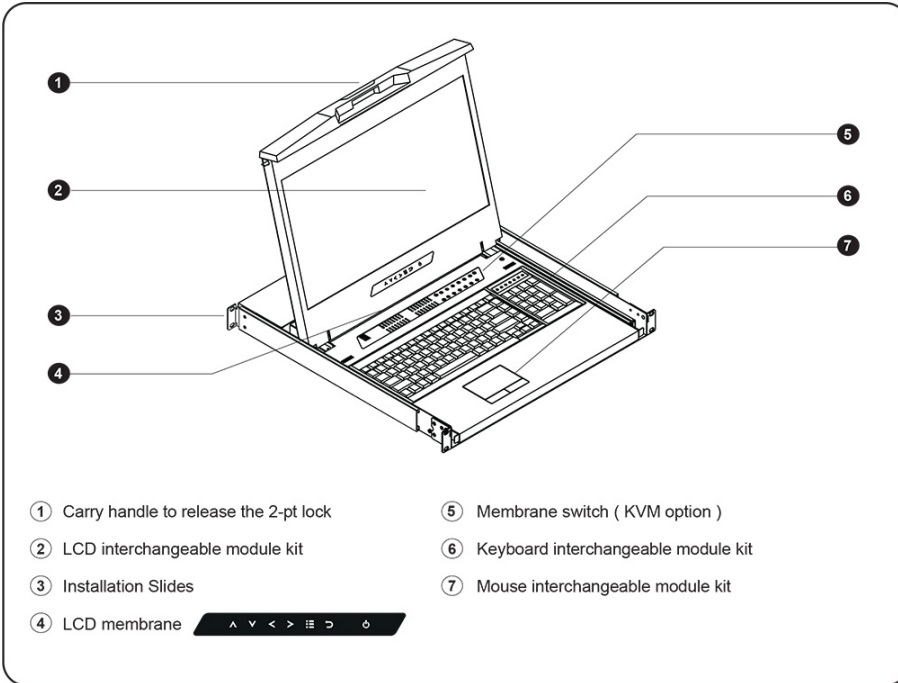

DIMENSION

This is subject to change without Notice. Final Drawings Will be Provided for Approval after Order.

Front View

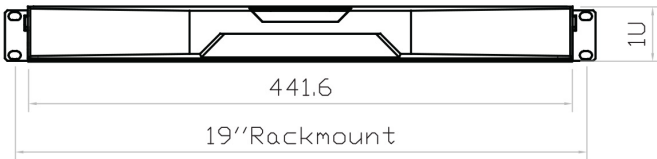

Top View

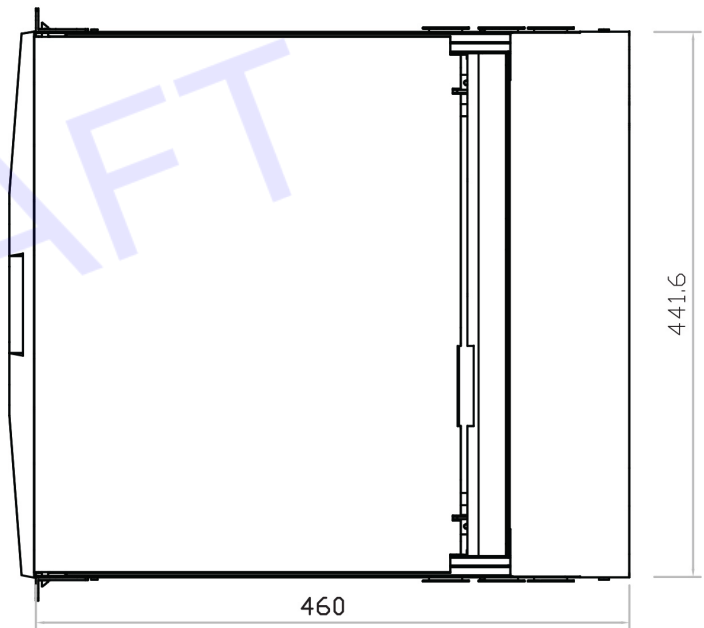

Rear View

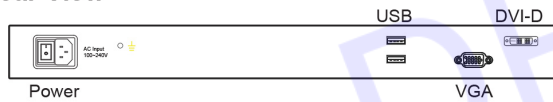

Side View

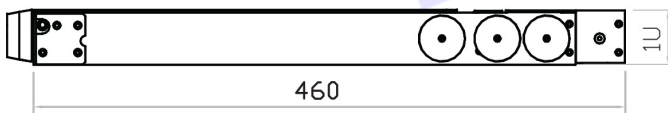

Drawing No.: NW119HDe-05042022-V1