

1U Rackmount 17" Wide, 1920 x 1200 WUXGA, with 104 key notepad keyboard w/ touchpad (e), 6ft long DVI +USB+ Audio KVM Cables

Model: NW117Xe



FEATURES:

- 1U 16.2" LCD console drawer
- 1920 x 1200 WUXGA native resolution / 16.7M colors (8-bit)
- HDMI 1.4 + DVI-D + VGA video input / USB KB / MS
- 104-key keyboard with either touchpad or trackball
- Short depth design of 480mm
- One Man installation design
- New enhanced aesthetics with molded front handle
- 2-year standard warranty (upgradable up to 5 years)

SPECIFICATIONS:

Console Port	
Video input	HDMI 1.4 + DVI-D single link + VGA
KB / MS	USB interface
VGA console 6ft cable : NB-6A	Drawer end : DB-15 + USB type A x 2 Server end : DB-15 + USB type A x 2
or	
DVI-D console 6ft cable : NX-6A	Drawer end : DVI-D + USB type A x 2 Server end : DVI-D + USB type A x 2

LCD Panel	
Panel size (diagonal)	16.2"
Native resolution	1920 x 1200
Brightness (cd/m ²)	300
Contrast ratio (typ.)	800 : 1
Colors	16.7 M, 8-bit
Viewing angle (L/R/U/D)	89/89/89/89
Response time (ms)	30
Dot pitch (mm)	0.191
Display area (mm)	343.8H x 214.9V
Surface treatment	Anti-glare, Hard-coating
Surface hardness	3H
Backlight type	LED
MTBF (hrs)	20,000

Mounting Distance	
Single console drawer	490 ~ 720 mm 19.3 ~ 28.3 inch
Console w/ KVM drawer	490 ~ 800 mm 19.3 ~ 31.5 inch

Audio Option		
Input	Connector	3.5mm stereo jack
	Impedance / Power level	30kΩ / 750mV
Output	Connector	3.5mm stereo jack
	Resistance / Power level	30kΩ / 2.8V
Speaker	Dual stereo	2W x 2

OPTIONS

- Front USB hub port for device access
- 3G / HD / SD-SDI Broadcast-grade input
- Audio input & output
- 2-post rack mounting brackets (ORB-2.1)
- DC power : 12V / 24V / 48V / 125V
- MAC or SUN Micro keyboard options available

Power		
Input	Auto-sensing 100 to 240VAC, 50 / 60Hz	
Consumption (console / KVM)	Screen on	Max. 34W / Max. 59W
	Power saving mode	Max. 4W / Max. 29W
	Power button on	Max. 1W / Nil

Environment	
Operating temp.	0 to 55°C degree
Storage temp.	-20 to 60°C degree
Operating humidity	20~90%, non-condensing
Storage humidity	5 ~90%, non-condensing
Operating altitude	16,000 ft
Non-operating altitude	40,000 ft
Shock	10G acceleration (11ms duration)
Vibration	10~300Hz 0.5G RMS random vibration

Compliance	
EMC	FCC & CE certified
Safety	CE / LVD certified
Environment	RoHS2 & REACH compliant

Physical		
Dimensions; (W x D x H)	Single console	442 x 480 x 44 mm 17.4 x 18.9 x 1.73 inch
	Console w/ KVM	442 x 580 x 44 mm 17.4 x 22.8 x 1.73 inch
Packing (W x D x H)	Single console / Console w/ KVM	590 x 808 x 140 mm 23.2 x 31.8 x 5.5 inch
	Net weight	Single console
Console w/ KVM		12.1 kg / 26.6 lb
Gross weight	Single console	15.8 kg / 34.8 lb
	Console w/ KVM	18.1 kg / 39.8 lb

***Specifications subject to change without notice, not responsible for typographical errors.**

Modified Date: 05-05-2021

MODELS with KVM

* Stands for 17" or 19" LCD sizs.

2K KVM	IP	Remote	8-port		
	0	0	NW117X-D8		

DVI-D KVM	IP	Remote	12-port		
	0	0	NW117X-D12		

Matrix CAT6 KVM	IP	Remote	8-port	16-port	32-port
	1	1	-	NW117X-MC1116	NW117X-MC1132
	2	1	-	NW117X-MC2116	NW117X-MC3224
	0	1	-	NW117X-MC0116	NW117X-MC0132
	0	2	-	NW117X-MC0216	NW117X-MC0232
	0	3	-	NW117X-MC0316	NW117X-MC0332

CAT6 Combo KVM	IP	Remote	8-port	16-port	32-port
	1	0	NW117X-CIP8	NW117X-CIP16	NW117X-CIP32
	0	1	NW117X-CCE8	NW117X-CCE16	NW117X-CCE32
	0	0	NW117X-C8	NW117X-C16	NW117X-C32

Matrix DB-15 KVM	IP	Remote	8-port	16-port
	1	1	NW117X-M118	NW117X-M1116
	2	1	NW117X-M218	NW117X-M2116
	0	1	NW117X-M018	NW117X-M0116
	0	2	NW117X-M028	NW117X-M0216
	0	3	NW117X-M038	NW117X-M0316

Combo DB-15 KVM	IP	Remote	8-port	16-port
	1	0	NW117X-IP8	NW117X-IP16
	0	1	NW117X-CE8	NW117X-CE8
	0	0	NW117X-S8	NW117X-S16

USB HUB DB-15 KVM	IP	Remote	8-port	16-port
	1	0	NW117XIP-82H	NW117XIP-162H
	0	1	NW117X-CE8H	NW117X-CE16H
	0	0	NW117X-801H	NW117X-1601H

2K KVM Cable



NK6D (6 ft)
DVI-D KVM cable



NK6H (6 ft)
HDMI KVM cable

Resolution 16:9 - max. 2560 x 1440
Support **: 16:10 - max. 1920 x 1200
4:3 - max. 1600 x 1200

DB-15 VGA USB KVM Cable

NB - 6 (6 ft)	NB - 10 (10 ft)	NB - 15 (15 ft)
Resolution Support :	16:10 - max. 1920 x 1200	
	16:9 - max. 1920 x 1080	
	4:3 - max. 1600 x 1200	
** Resolution related to LCD specification		

DVI-D USB KVM Cable

Resolution Support :	16:10 - max. 1920 x 1200	
	16:9 - max. 1920 x 1080	
	4:3 - max. 1600 x 1200	
		NI - 6 (6 ft)
		NI - 15 (15 ft)
** Resolution related to LCD specification		

CAT6 KVM Dongle



IF-DUSBP
DP - USB dongle



IF-DUSBH
HDMI - USB dongle



IF-DUSBD
DVI - USB dongle



IF-DUSB
VGA - USB dongle



IF-DPS2
VGA - PS/2 dongle

Resolution 16:9 - max. 1920 x 1080
Support : 4:3 - max. 1600 x 1200

** Resolution related to LCD specification

STANDARD KEYBOARD

e keyboard integrated with touchpad

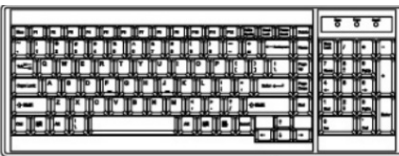

b keyboard integrated with trackball

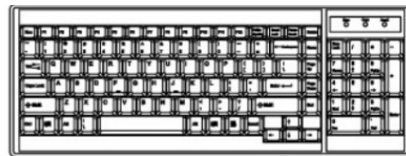

KEYBOARD OPTIONS (US layout only)

Me Mac keyboard with touchpad



Se S keyboard with touchpad

Mb Mac keyboard with trackball

Sb S keyboard with trackball



Supporting layouts

America		United States			
EMEA					
	United Kingdom	Germany	France	Spain	Norway
	Italy	Russia	Switzerland	Netherlands	Portugal
	Asia				
	China	Japan	Korea	Arabia	Turkey

PHOTOS:

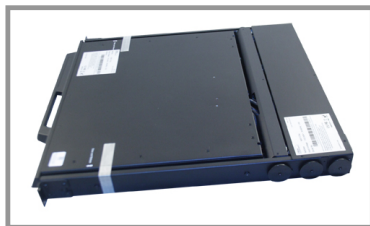

DRAWINGS FOR REFERENCE:

This is subject to change without Notice. Final Drawings Will be Provided for Approval after Order.

Rear View

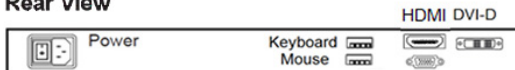

HDMI DVI-D

VGA

Interface : 1 x VGA + 1 x DVI-D + 1 x HDMI
+
2 x USB for K/B & MS

Front View

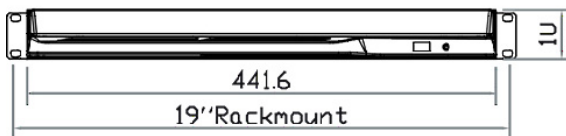

Side View

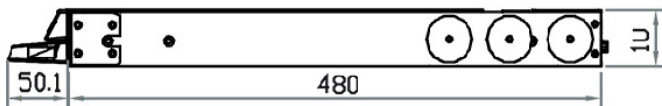

Top View

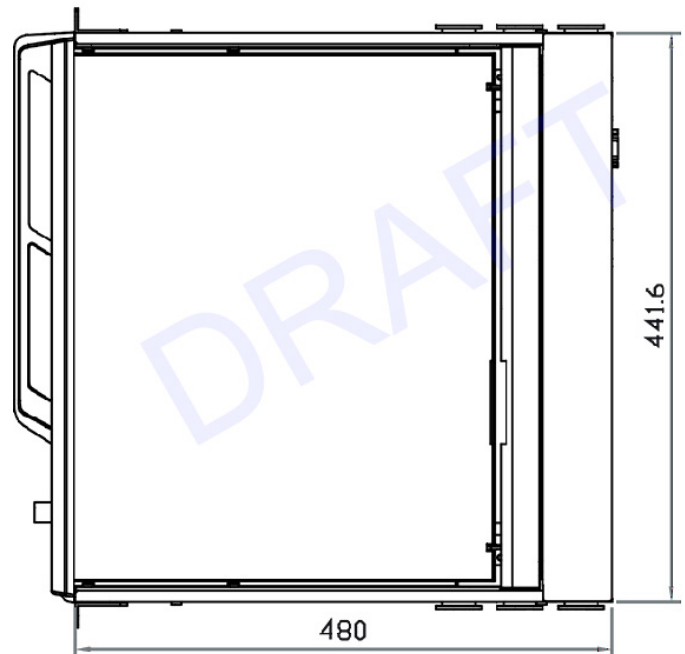

CHANGED I/O

