

1U Rackmount 17" Wide, 1920 x 1200 WUXGA with VGA + DVI-D + HDMI Video Input with 104 Key Notepad keyboard w/ Trackball (b)

Model: NW117Xb



FEATURES:

- 1U 16.2" LCD console drawer
- 1920 x 1200 WUXGA native resolution / 16.7M colors (8-bit)
- VGA + DVI-D + HDMI video input / USB KB / MS
- 104-key keyboard with either touchpad or trackball
- Short depth design of 480mm
- One Man installation design
- New enhanced aesthetics with molded front handle
- 2-year standard warranty (upgradable up to 5 years)

SPECIFICATIONS:

Console Port	
Video input	HDMI 1.4 + DVI-D single link + VGA
KB / MS	USB interface
VGA console 6ft cable : NB-6A	Drawer end : DB-15 + USB type A x 2 Server end : DB-15 + USB type A x 2
or	Drawer end : DVI-D + USB type A x 2 Server end : DVI-D + USB type A x 2
DVI-D console 6ft cable : CV-6A	Drawer end : DVI-D + USB type A x 2 Server end : DVI-D + USB type A x 2

LCD Panel	
Panel size (diagonal)	16.2"
Native resolution	1920 x 1200
Brightness (cd/m ²)	300
Contrast ratio (typ.)	800 : 1
Colors	16.7 M, 8-bit
Viewing angle (L/R/U/D)	89/89/89/89
Response time (ms)	30
Dot pitch (mm)	0.191
Display area (mm)	343.8H x 214.9V
Surface treatment	Anti-glare, Hard-coating
Surface hardness	3H
Backlight type	LED
MTBF (hrs)	20,000

Mounting Distance	
Single console drawer	490 ~ 720 mm 19.3 ~ 28.3 inch
Console w/ KVM drawer	490 ~ 800 mm 19.3 ~ 31.5 inch

Audio Option		
Input	Connector	3.5mm stereo jack
	Impedance / Power level	30kΩ / 750mV
Output	Connector	3.5mm stereo jack
	Resistance / Power level	30kΩ / 2.8V
Speaker	Dual stereo	2W x 2

OPTIONS

- Front USB hub port for device access
- 3G / HD / SD-SDI Broadcast-grade input
- Audio input & output
- 2-post rack mounting brackets
- DC power : 12V / 24V / 48V / 125V
- MAC or SUN Micro keyboard options available
- Touchscreen : Resistive 1-pt

Power		
Input	Auto-sensing 100 to 240VAC, 50 / 60Hz	
Consumption (console / KVM)	Screen on	Max. 34W / Max. 59W
	Power saving mode	Max. 4W / Max. 29W
	Power button on	Max. 1W / Nil

Environment	
Operating temp.	0 to 55°C degree
Storage temp.	-20 to 60°C degree
Operating humidity	20~90%, non-condensing
Storage humidity	5 ~90%, non-condensing
Operating altitude	16,000 ft
Non-operating altitude	40,000 ft
Shock	10G acceleration (11ms duration)
Vibration	10~300Hz 0.5G RMS random vibration

Compliance	
EMC	FCC & CE certified
Safety	CE / LVD certified
Environment	RoHS2 & REACH compliant

Physical		
Dimensions; (W x D x H)	Single console	442 x 480 x 44 mm 17.4 x 18.9 x 1.73 inch
	Console w/ KVM	442 x 580 x 44 mm 17.4 x 22.8 x 1.73 inch
Packing (W x D x H)	Single console	590 x 808 x 140 mm
	Console w/ KVM	23.2 x 31.8 x 5.5 inch
Net weight	Single console	10.9 kg / 24 lb
	Console w/ KVM	12.1 kg / 26.6 lb
Gross weight	Single console	15.8 kg / 34.8 lb
	Console w/ KVM	18.1 kg / 39.8 lb

*Specifications subject to change without notice, not responsible for typographical errors.

MODELS with KVM

2K KVM	IP	Remote	8-port	
	0	0	NW119HD-D8	

2K KVM Cable



NK6D (6 ft)
DVI-D KVM cable



NK6H (6 ft)
HDMI KVM cable

Resolution Support **: 16:9 - max. 2560 x 1440
16:10 - max. 1920 x 1200
4:3 - max. 1600 x 1200

DVI-D KVM	IP	Remote	12-port	
	0	0	NW119HD-D12	

DVI-D USB KVM Cable

Resolution Support **: 16:10 - max. 1920 x 1200
16:9 - max. 1920 x 1080
4:3 - max. 1600 x 1200



NI - 6 (6 ft)
NI - 15 (15 ft)

Matrix CAT6 KVM	IP	Remote	8-port	16-port	32-port
	1	1	-	NW119HD-MC1116	NW119HD-MC1132
	2	1	-	NW119HD-MC2116	NW119HD-MC3224
	0	1	-	NW119HD-MC0116	NW119HD-MC0132
	0	2	-	NW119HD-MC0216	NW119HD-MC0232
0	3	-	NW119HD-MC0316	NW119HD-MC0332	

CAT6 KVM Dongle



USB-C dongle



IF-DUSBP
DP - USB dongle



IF-DUSBH
HDMI - USB dongle



IF-DUSBD
DVI - USB dongle



IF-DUSB
VGA - USB dongle

Resolution Support **: 16:10 - max. 1920 x 1200
16:9 - max. 1920 x 1080
4:3 - max. 1600 x 1200

CAT6 Combo KVM	IP	Remote	8-port	16-port	32-port
	1	0	NW119HD-CIP8	NW119HD-CIP16	NW119HD-CIP32
	0	1	NW119HD-CCE8	NW119HD-CCE16	NW119HD-CCE32
0	0	NW119HD-C8	NW119HD-C16	NW119HD-C32	

Matrix DB-15 KVM	IP	Remote	8-port	16-port
	1	1	NW119HD-M118	NW119HD-M1116
	2	1	NW119HD-M218	NW119HD-M2116
	0	1	NW119HD-M018	NW119HD-M0116
	0	2	NW119HD-M028	NW119HD-M0216
0	3	NW119HD-M038	NW119HD-M0316	

DB-15 VGA USB KVM Cable



NB - 6 (6 ft)



NB - 10 (10 ft)





NB - 15 (15 ft)

Resolution Support **: 16:10 - max. 1920 x 1200
16:9 - max. 1920 x 1080
4:3 - max. 1600 x 1200

Combo DB-15 KVM	IP	Remote	8-port	16-port
	1	0	NW119HD-IP8	NW119HD-IP16
	0	1	NW119HD-CE8	NW119HD-CE8
0	0	NW119HD-S8	NW119HD-S16	

IP Console







High Performance KVM Access Over IP

Connector : RJ45
 User management: 1 x active user, 15-user login
 Network protocol: DHCP / BOOTP / DNS
 Security : TLS 1.3, AES, LDAP, Active Directory (AD), HTTP(s)
 Browser : Chrome, Firefox, Edge, etc.
 Resolution : 16:9 - max. 1920x1080 / 16:10 - max. 1920x1200 / 4:3 - max. 1600x1200

STANDARD KEYBOARD



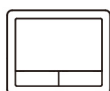
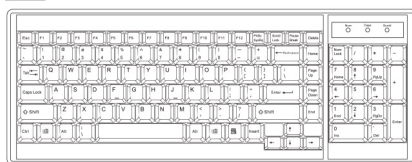





Ge G keyboard with touchpad



Gb G keyboard with trackball



Supporting layouts

America						
	U.S.					
EMEA						
	U.K.	Germany	France	Russia	Spain	Italy
Asia						
	Japan	Korea				

KEYBOARD OPTIONS

* US layout only

Me Mac keyboard with touchpad



Se S keyboard with touchpad

Mb Mac keyboard with trackball

Sb S keyboard with trackball



STRUCTURE DIAGRAM

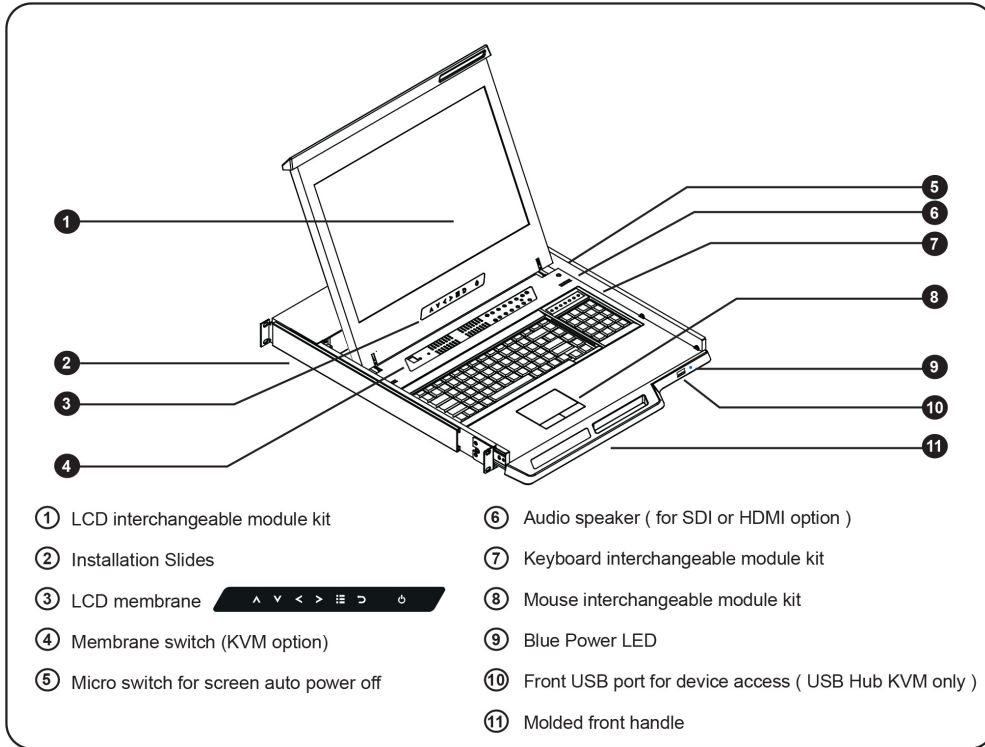

DIMENSION

This is subject to change without Notice. Final Drawings Will be Provided for Approval after Order.

Front View

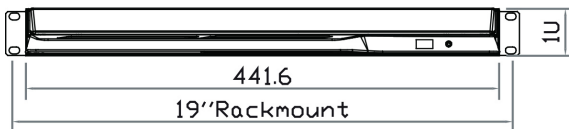

Rear View

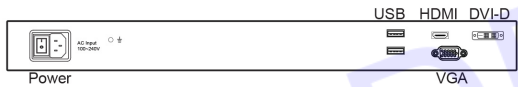

Side View

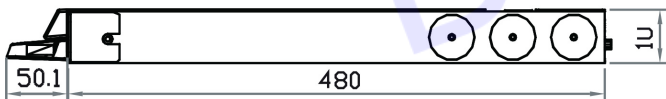

Top View

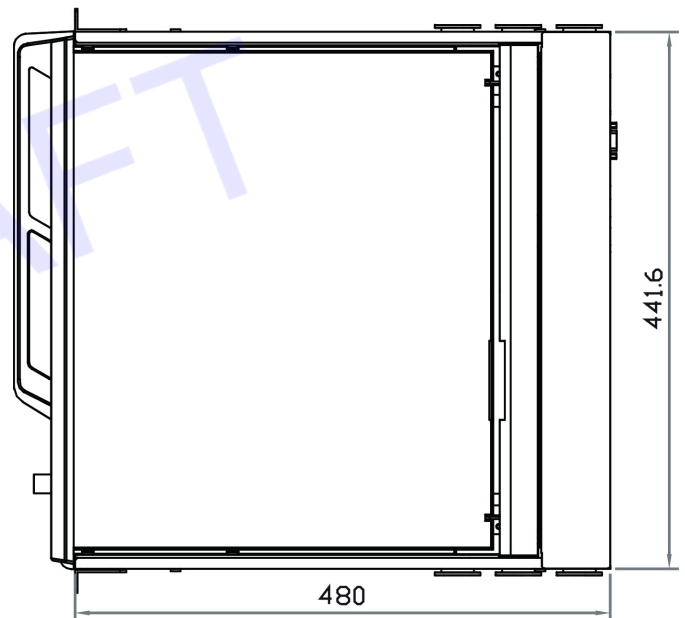

Drawing No.: NW117Xb-05042022-V1