



**1U 24" WUXGA LCD Console Drawer, DVI-D + VGA
Video input, USB KB / MS, 104-key keyboard
w/ Touchpad (e), Right Side Open**

MODEL: NVPW1240e-R



FEATURES:

- 1U 24" LCD console drawer
- 1920 x 1200 WUXGA native resolution / 16.7M colors
- DVI-D + VGA video input / USB KB / MS
- 104-key keyboard with either touchpad or trackball
- One Man installation design
- Enhanced aesthetics with new molded front panel and 2-point lock
- 2-year standard warranty (upgradable up to 5 years)

SPECIFICATIONS:

Console Port	
Video input	VGA + DVI-D single link
KB / MS	USB interface
VGA console 6ft cable : NB-6 or	Drawer end : DB-15 + USB type A x 2 Server end : DB-15 + USB type A x 2
DVI-D console 6ft cable : CV-6A	Drawer end : DVI-D + USB type A x 2 Server end : DVI-D + USB type A x 2

LCD Panel	
Panel size (diagonal)	24.1"
Native resolution	1920 x 1200
Brightness (cd/m ²)	300
Contrast ratio (typ.)	1000 : 1
Colors	16.7 M
Viewing angle (L/R/U/D)	89/89/89/89
Response time (ms)	14
Dot pitch (mm)	0.27
Display area (mm)	518.4H x 324V
Surface treatment	Anti-glare, Hard-coating
Surface hardness	3H
Backlight type	LED
MTBF (hrs)	30,000

Mounting Distance	
Single console drawer	660 ~ 890 mm 26 ~ 35 inch
Console w/ KVM drawer	660 ~ 970 mm 26 ~ 38.2 inch

Video Option		
Digital	HDMI	HDMI 1.3 / HDCP 1.1

OPTIONS

- Front USB hub port for device access
- HDMI 1.3 video input
- 3G / HD / SD-SDI Broadcast-grade input
- DC power : 12V / 24V / 48V / 125V
- MAC or SUN Micro keyboard options available

Power		
Input	Auto-sensing 100 to 240VAC, 50 / 60Hz	
Consumption (console / KVM)	Screen on	Max. 33W / Max. 65W
	Power saving mode	Max. 2W / Max. 30W
	Power button on	Max. 1W / Nil

Environment	
Operating temp.	0 to 55°C degree
Storage temp.	-20 to 60°C degree
Operating humidity	20~90%, non-condensing
Storage humidity	5 ~90%, non-condensing
Operating altitude	16,000 ft
Non-operating altitude	40,000 ft
Shock	10G acceleration (11ms duration)
Vibration	10~300Hz 0.5G RMS random vibration

Compliance	
EMC	FCC & CE
Safety	CE / LVD & UKCA
Environment	RoHS3 & REACH

Physical		
Dimensions; (W x D x H)	Single console	442 x 690 x 44 mm 17.4 x 27.2 x 1.73 inch
	Console w/ KVM	442 x 800 x 44 mm 17.4 x 31.5 x 1.73 inch
Packing (W x D x H)	Single console / Console w/ KVM	590 x 965 x 136 mm 23.2 x 38 x 5.4 inch
	Net weight	Single console
Console w/ KVM		16.1 kg / 35.4 lb
Gross weight	Single console	19.5 kg / 42.9 lb
	Console w/ KVM	22 kg / 48.4 lb

MODELS with KVM

2K KVM	IP	Remote	8-port
	0	0	NVPW1240-D8

2K KVM Cable



NK6D (6 ft)
DVI-D KVM cable



NK6H (6 ft)
HDMI KVM cable

Resolution Support **: 16:9 - max. 2560 x 1440
16:10 - max. 1920 x 1200
4:3 - max. 1600 x 1200

DVI-D KVM	IP	Remote	12-port
	0	0	NVPW1240-D12

DVI-D USB KVM Cable

Resolution Support **: 16:10 - max. 1920 x 1200
16:9 - max. 1920 x 1080
4:3 - max. 1600 x 1200



NI - 6 (6 ft)
NI - 15 (15 ft)

Matrix CAT6 KVM	IP	Remote	8-port	16-port	32-port
	1	1	-	NVPW1240-MC1116	NVPW1240-MC1132
	2	1	-	NVPW1240-MC2116	NVPW1240-MC3224
	0	1	-	NVPW1240-MC0116	NVPW1240-MC0132
	0	2	-	NVPW1240-MC0216	NVPW1240-MC0232
	0	3	-	NVPW1240-MC0316	NVPW1240-MC0332

CAT6 KVM Dongle



USB-C dongle



IF-DUSBP
DP - USB dongle



IF-DUSBH
HDMI - USB dongle



IF-DUSBD
DVI - USB dongle



IF-DUSB
VGA - USB dongle

Resolution Support **: 16:10 - max. 1920 x 1200
16:9 - max. 1920 x 1080
4:3 - max. 1600 x 1200

CAT6 Combo KVM	IP	Remote	8-port	16-port	32-port
	1	0	NVPW1240-CIP8	NVPW1240-CIP16	NVPW1240-CIP32
	0	1	NVPW1240-CCE8	NVPW1240-CCE16	NVPW1240-CCE32
	0	0	NVPW1240-C8	NVPW1240-C16	NVPW1240-C32

Matrix DB-15 KVM	IP	Remote	8-port	16-port
	1	1	NVPW1240-M118	NVPW1240-M1116
	2	1	NVPW1240-M218	NVPW1240-M2116
	0	1	NVPW1240-M018	NVPW1240-M0116
	0	2	NVPW1240-M028	NVPW1240-M0216
	0	3	NVPW1240-M038	NVPW1240-M0316

DB-15 VGA USB KVM Cable



NB - 6 (6 ft)



NB - 10 (10 ft)





NB - 15 (15 ft)

Resolution Support **: 16:10 - max. 1920 x 1200
16:9 - max. 1920 x 1080
4:3 - max. 1600 x 1200

Combo DB-15 KVM	IP	Remote	8-port	16-port
	1	0	NVPW1240-IP8	NVPW1240-IP16
	0	1	NVPW1240-CE8	NVPW1240-CE8
	0	0	NVPW1240-S8	NVPW1240-S16

IP Console







High Performance KVM Access Over IP

Connector : RJ45

User management : 1 x active user, 15-user login

Network protocol : DHCP / BOOTP / DNS

Security : TLS 1.3, AES, LDAP, Active Directory (AD), HTTP(s)

Browser : Chrome, Firefox, Edge, etc.

Resolution : 16:9 - max. 1920x1080 / 16:10 - max. 1920x1200 / 4:3 - max. 1600x1200

STANDARD KEYBOARD

Ge G keyboard with touchpad

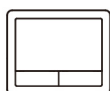
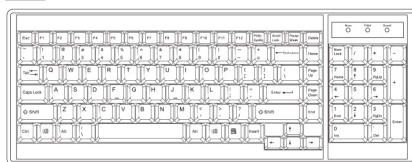

Gb G keyboard with trackball

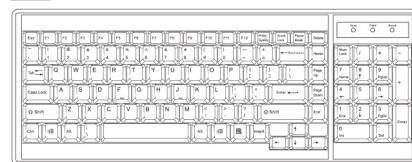

Supporting layouts

America 
U.S.

EMEA      
U.K. Germany France Russia Spain Italy

Asia  
Japan Korea

KEYBOARD OPTIONS

* US layout only

Me Mac keyboard with touchpad



Se S keyboard with touchpad

Mb Mac keyboard with trackball

Sb S keyboard with trackball



STRUCTURE DIAGRAM

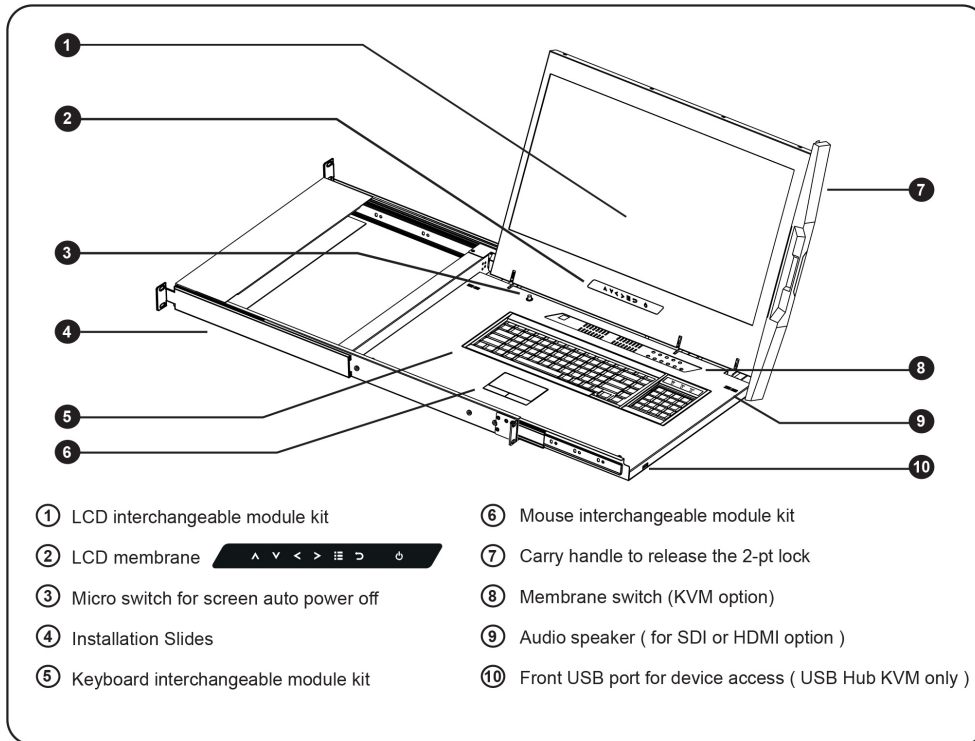

DIMENSION

This is subject to change without Notice. Final Drawings Will be Provided for Approval after Order.

Front View

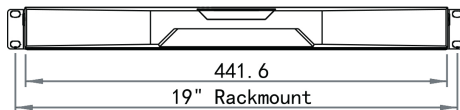

Rear View



Side View

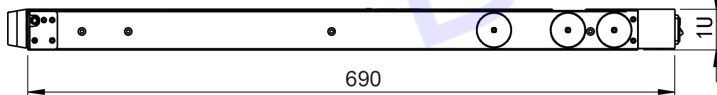

Top View

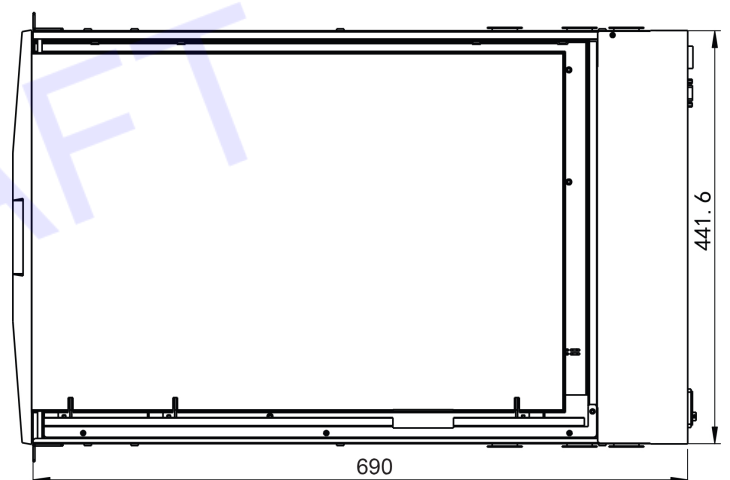

Drawing No.: NVPW1240e-R-05112022-V1