



2U Dual Slide 19" FHD LCD Console Drawer
1280x1024 with VGA Video input / USB KB / MS
104-Key Keyboard with Trackball (b)
Short depth design of 480mm

Model: NVP2419b

BENEFITS:

- 2U 19" LCD console drawer
- Dual slide - LCD and keyboard slide independently
- 1280 x 1024 native resolution / 16.7M colors
- 104-key keyboard with either touchpad or trackball
- Short depth design of 480mm
- One Man installation design
- Enhanced aesthetics with molded front handle and two point lock
- 2-year standard warranty (upgradable up to 5 years)

OPTIONS:

- HDMI 1.4 + DVI-D (AV4.4)
- HDMI 1.4 video input (HDMI)
- 3G / HD / SD-SDI Broadcast-grade input (SDI)
- S-Video + Composite (BNC)
- DC power : 12V / 24V / 48V / 125V
- MAC or SUN Micro keyboard options available
- 19" Touchscreen : Resistive 1-pt

SPECIFICATIONS

Console Port	
Video input	VGA
KB / MS	USB interface
VGA console 6ft cable : NB-6A	Drawer end : DB-15 +USB type A x 2 Server end : DB-15 +USB type A x 2

LCD Panel	
Panel size (diagonal)	19"
Native resolution	1280 x 1024
Brightness (cd/m ²)	250
Contrast ratio (typ.)	1000 : 1
Colors	16.7 M
Viewing angle (L/R/U/D)	85/85/80/80
Response time (ms)	5
Dot pitch (mm)	0.264
Display area (mm)	376.32H x 270.33V
Surface treatment	Haze 25%, Hard-coating
Surface hardness	3H
Backlight type	LED
MTBF (hrs)	30,000

Physical		
Product (W x D x H)	Single console	442 x 480 x 88 mm 17.4 x 18.9 x 3.5 inch
	Console w/ KVM	442 x 480 x 88 mm 17.4 x 18.9 x 3.5 inch
Packing (W x D x H)	Single console / Console w/ KVM	585 x 620 x 190 mm 23 x 24.4 x 7.5 inch
	Single console	20.4 kg / 44.9 lb
Net weight	Console w/ KVM	21.1 kg / 46.4 lb
	Single console	24.8 kg / 54.6 lb
Gross weight	Single console	27 kg / 59.4 lb
	Console w/ KVM	

Mounting Distance	
Single console drawer / Console w/ KVM drawer	490 ~ 700 mm 19.3 ~ 27.6 inch

Video Option		
Digital	DVI	DVI-D single link
	HDMI	HDMI 1.4 / HDCP 1.4
Analog	S-Video (4-pin)	NTSC & PAL
	Composite (BNC)	NTSC & PAL

Power		
Input	Auto-sensing 100 to 240VAC, 50 / 60Hz	
Consumption (console / KVM)	Screen on	Max. 22W / Max. 55W
	Power saving mode	Max. 2W / Max. 34W
	Power button off	Max. 1W / Nil

Environment	
Operating temp.	0 to 55°C degree
Storage temp.	-20 to 60°C degree
Operating humidity	20~90%, non-condensing
Storage humidity	5 ~90%, non-condensing
Operating altitude	16,000 ft
Non-operating altitude	40,000 ft
Shock	10G acceleration (11ms duration)
Vibration	10~300Hz 0.5G RMS random vibration

Compliance	
EMC	FCC, CE
Safety	CE / LVD & UKCA
Environment	RoHS3 & REACH

MODELS with KVM

2K KVM	IP	Remote	8-port
	0	0	NVP2419-8Ke

2K KVM Cable



NK6D (6 ft)
DVI-D KVM cable



NK6H (6 ft)
HDMI KVM cable

Resolution Support **: 16:9 - max. 2560 x 1440
16:10 - max. 1920 x 1200
4:3 - max. 1600 x 1200

DVI-D KVM	IP	Remote	12-port
	0	0	NVP2419-12Ke

DVI-D USB KVM Cable

Resolution Support **: 16:10 - max. 1920 x 1200
16:9 - max. 1920 x 1080
4:3 - max. 1600 x 1200



NI - 6 (6 ft)
NI - 15 (15 ft)

Matrix CAT6 KVM	IP	Rem	8-port	16-port	32-port
	1	1	-	NVP2419-MC1116	NVP2419-MC1132
	2	1	-	NVP2419-MC2116	NVP2419-MC3224
	0	1	-	NVP2419-MC0116	NVP2419-MC0132
	0	2	-	NVP2419-MC0216	NVP2419-MC0232
	0	3	-	NVP2419-MC0316	NVP2419-MC0332

CAT6 KVM Dongle



USB-C dongle



IF-DUSBP
DP - USB dongle



IF-DUSBH
HDMI - USB dongle



IF-DUSBD
DVI - USB dongle



IF-DUSB
VGA - USB dongle

Resolution Support **: 16:10 - max. 1920 x 1200
16:9 - max. 1920 x 1080
4:3 - max. 1600 x 1200

CAT6 Combo KVM	IP	Rem	8-port	16-port	32-port
	1	0	NVP2419-CIP8	NVP2419-CIP16	NVP2419-CIP32
	0	1	NVP2419-CCE8	NVP2419-CCE16	NVP2419-CCE32
0	0	NVP2419-C8	NVP2419-C16	NVP2419-C32	

Combo DB-15 KVM	IP	Remote	8-port	16-port
	1	0	NVP2419-IP8	NVP2419-IP16
	0	1	NVP2419-CE8	NVP2419-CE8
0	0	NVP2419-S8	NVP2419-S16	

DB-15 VGA USB KVM Cable



NB - 6 (6 ft)



NB - 10 (10 ft)





NB - 15 (15 ft)

Resolution Support **: 16:10 - max. 1920 x 1200
16:9 - max. 1920 x 1080
4:3 - max. 1600 x 1200

IP Console







Connector : RJ45
 User management : 1 x active user, 15-user login
 Network protocol : DHCP / BOOTP / DNS
 Security : TLS 1.3, AES, LDAP, Active Directory (AD), HTTP(s)
 Browser : Chrome, Firefox, Edge, etc.
 Resolution : 16:9 - max. 1920x1080 / 16:10 - max. 1920x1200 / 4:3 - max. 1600x1200

High Performance KVM Access Over IP

STANDARD KEYBOARD

Ge G keyboard with touchpad

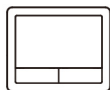
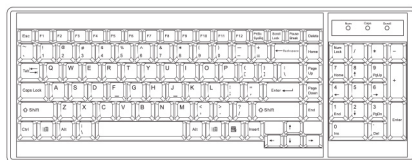

Gb G keyboard with trackball

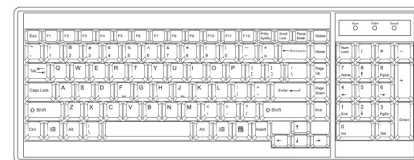

Supporting layouts

America



U.S.

EMEA



U.K.



Germany



France



Russia



Spain



Italy

Asia



Japan



Korea

KEYBOARD OPTIONS

* US layout only

Me Mac keyboard with touchpad



Se S keyboard with touchpad

Sb S keyboard with trackball



Modified Date: 04-27-2022

STRUCTURE DIAGRAM

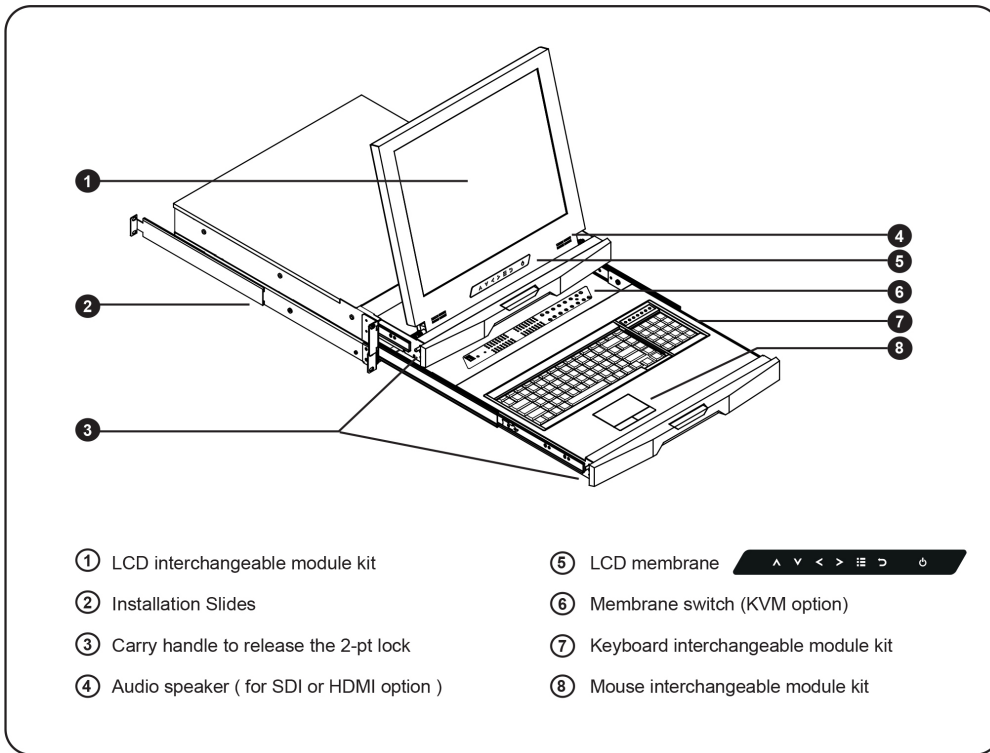

DIMENSION

This is subject to change without Notice. Final Drawings Will be Provided for Approval after Order.

Front View

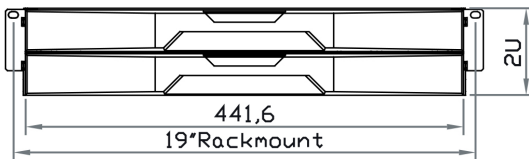

Top View

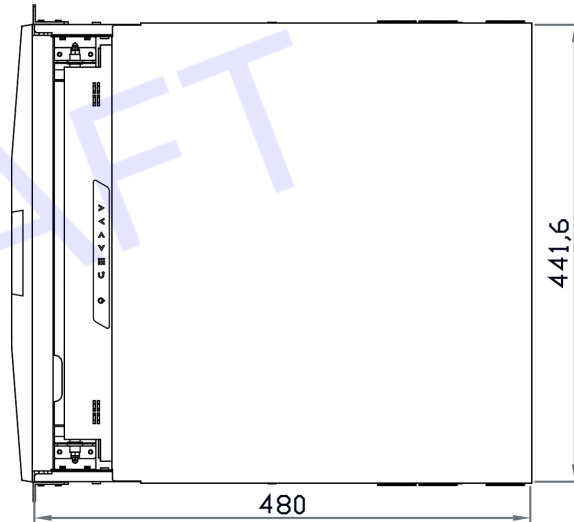

Rear View

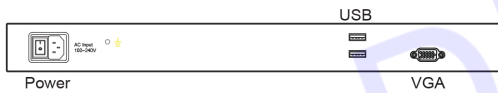

Side View

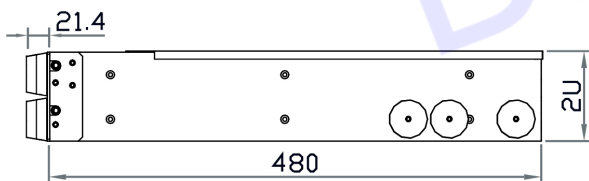

Drawing No.: NVP2419b-04272022-V1