



**2U Dual Slide 17" FHD LCD Console Drawer**  
**1280x1024 with VGA + DVI-D Video input / USB KB / MS**  
**104-Key Keyboard with Touchpad (e)**  
**Short depth design of 480mm**

**Model: NVP2417e-DVI**

**BENEFITS:**

- 2U 17" LCD console drawer
- Dual slide - LCD and keyboard slide independently
- 1280 x 1024 native resolution / 16.7M colors
- 104-key keyboard with either touchpad or trackball
- Short depth design of 480mm
- One Man installation design
- Enhanced aesthetics with molded front handle and two point lock
- 2-year standard warranty ( upgradable up to 5 years )

**OPTIONS:**

- HDMI 1.4 + DVI-D ( AV4.4 )
- HDMI 1.4 video input ( HDMI )
- 3G / HD / SD-SDI Broadcast-grade input ( SDI )
- S-Video + Composite ( BNC )
- DC power : 12V / 24V / 48V / 125V
- MAC or SUN Micro keyboard options available
- 17" Touchscreen : Projected Capacitive 10-pt / Capacitive 1-pt / Resistive 1-pt

**SPECIFICATIONS**

| Console Port                  |  |
|-------------------------------|--|
| Video input                   | VGA + DVI-D  |
| KB / MS                       | USB interface  |
| VGA console 6ft cable : NB-6A | Drawer end : DB-15 +USB type A x 2<br>Server end : DB-15 +USB type A x 2 |

| LCD Panel                        |                        |
|----------------------------------|------------------------|
| Panel size ( diagonal )          | 17"                    |
| Native resolution                | 1280 x 1024            |
| Brightness ( cd/m <sup>2</sup> ) | 250                    |
| Contrast ratio ( typ. )          | 1000 : 1               |
| Colors                           | 16.7 M                 |
| Viewing angle ( L/R/U/D )        | 85/85/80/80            |
| Response time ( ms )             | 5                      |
| Dot pitch ( mm )                 | 0.264                  |
| Display area ( mm )              | 337.92H x 270.33V      |
| Surface treatment                | Haze 25%, Hard-coating |
| Surface hardness                 | 3H                     |
| Backlight type                   | LED                    |
| MTBF (hrs)                       | 30,000                 |

| Physical              |                                 |  |
|-----------------------|---------------------------------|--|
| Product ( W x D x H ) | Single console                  | 442 x 480 x 88 mm<br>17.4 x 18.9 x 3.5 inch                          |
|                       | Console w/ KVM                  | 442 x 480 x 88 mm<br>17.4 x 18.9 x 3.5 inch                          |
| Packing ( W x D x H ) | Single console / Console w/ KVM | 585 x 620 x 190 mm<br>23 x 24.4 x 7.5 inch                           |
|                       | Net weight                      | Single console 20.4 kg / 44.9 lb<br>Console w/ KVM 21.1 kg / 46.4 lb |
| Gross weight          | Single console                  | 24.8 kg / 54.6 lb  |
|                       | Console w/ KVM                  | 27 kg / 59.4 lb  |

| Mounting Distance                             |                                  |
|---|----------------------------------|
| Single console drawer / Console w/ KVM drawer | 490 ~ 700 mm<br>19.3 ~ 27.6 inch |

| Video Option |                   |                     |
|--------------|-------------------|---------------------|
| Digital      | DVI               | DVI-D single link   |
|              | HDMI              | HDMI 1.4 / HDCP 1.4 |
| Analog       | S-Video ( 4-pin ) | NTSC & PAL          |
|              | Composite ( BNC ) | NTSC & PAL          |

| Power                       |                                       |                     |
|-----------------------------|---------------------------------------|---------------------|
| Input                       | Auto-sensing 100 to 240VAC, 50 / 60Hz |                     |
| Consumption (console / KVM) | Screen on                             | Max. 22W / Max. 55W |
|                             | Power saving mode                     | Max. 2W / Max. 34W  |
|                             | Power button off                      | Max. 1W / Nil       |

| Environment            |                                    |
|------------------------|------------------------------------|
| Operating temp.        | 0 to 55°C degree                   |
| Storage temp.          | -20 to 60°C degree                 |
| Operating humidity     | 20~90%, non-condensing             |
| Storage humidity       | 5 ~90%, non-condensing             |
| Operating altitude     | 16,000 ft                          |
| Non-operating altitude | 40,000 ft                          |
| Shock                  | 10G acceleration ( 11ms duration ) |
| Vibration              | 10~300Hz 0.5G RMS random vibration |

| Compliance  |                 |
|-------------|-----------------|
| EMC         | FCC, CE         |
| Safety      | CE / LVD & UKCA |
| Environment | RoHS3 & REACH   |

## MODELS with KVM

|        |           |        |             |
|--------|-----------|--------|-------------|
| 2K KVM | <b>IP</b> | Remote | 8-port      |
|        | 0         | 0      | NVP2417-8Ke |

### 2K KVM Cable



NK6D (6 ft)  
DVI-D KVM cable



NK6H (6 ft)  
HDMI KVM cable

Resolution Support \*\*: 16:9 - max. 2560 x 1440  
16:10 - max. 1920 x 1200  
4:3 - max. 1600 x 1200

|           |           |        |              |
|-----------|-----------|--------|--------------|
| DVI-D KVM | <b>IP</b> | Remote | 12-port      |
|           | 0         | 0      | NVP2417-12Ke |

### DVI-D USB KVM Cable

Resolution Support \*\*: 16:10 - max. 1920 x 1200  
16:9 - max. 1920 x 1080  
4:3 - max. 1600 x 1200



NI - 6 (6 ft)  
NI - 15 (15 ft)

|                    |           |     |        |                |                |
|--------------------|-----------|-----|--------|----------------|----------------|
| Matrix<br>CAT6 KVM | <b>IP</b> | Rem | 8-port | 16-port        | 32-port        |
|                    | 1         | 1   | -      | NVP2417-MC1116 | NVP2417-MC1132 |
|                    | 2         | 1   | -      | NVP2417-MC2116 | NVP2417-MC3224 |
|                    | 0         | 1   | -      | NVP2417-MC0116 | NVP2417-MC0132 |
|                    | 0         | 2   | -      | NVP2417-MC0216 | NVP2417-MC0232 |
|                    | 0         | 3   | -      | NVP2417-MC0316 | NVP2417-MC0332 |

### CAT6 KVM Dongle



USB-C dongle



IF-DUSBP  
DP - USB dongle



IF-DUSBH  
HDMI - USB dongle



IF-DUSBD  
DVI - USB dongle



IF-DUSB  
VGA - USB dongle

Resolution Support \*\*: 16:10 - max. 1920 x 1200  
16:9 - max. 1920 x 1080  
4:3 - max. 1600 x 1200

|                      |           |     |              |               |               |
|----------------------|-----------|-----|--------------|---------------|---------------|
| CAT6<br>Combo<br>KVM | <b>IP</b> | Rem | 8-port       | 16-port       | 32-port       |
|                      | 1         | 0   | NVP2417-CIP8 | NVP2417-CIP16 | NVP2417-CIP32 |
|                      | 0         | 1   | NVP2417-CCE8 | NVP2417-CCE16 | NVP2417-CCE32 |
|                      | 0         | 0   | NVP2417-C8   | NVP2417-C16   | NVP2417-C32   |

|                    |           |        |             |              |
|--------------------|-----------|--------|-------------|--------------|
| Combo<br>DB-15 KVM | <b>IP</b> | Remote | 8-port      | 16-port      |
|                    | 1         | 0      | NVP2417-IP8 | NVP2417-IP16 |
|                    | 0         | 1      | NVP2417-CE8 | NVP2417-CE8  |
|                    | 0         | 0      | NVP2417-S8  | NVP2417-S16  |

### DB-15 VGA USB KVM Cable



NB - 6 (6 ft)



NB - 10 (10 ft)





NB - 15 (15 ft)

Resolution Support \*\*: 16:10 - max. 1920 x 1200  
16:9 - max. 1920 x 1080  
4:3 - max. 1600 x 1200

## IP Console







Connector : RJ45  
 User management : 1 x active user, 15-user login  
 Network protocol : DHCP / BOOTP / DNS  
 Security : TLS 1.3, AES, LDAP, Active Directory (AD), HTTP(s)  
 Browser : Chrome, Firefox, Edge, etc.  
 Resolution : 16:9 - max. 1920x1080 / 16:10 - max. 1920x1200 / 4:3 - max. 1600x1200

High Performance KVM Access Over IP

## STANDARD KEYBOARD

**Ge** G keyboard with touchpad

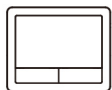
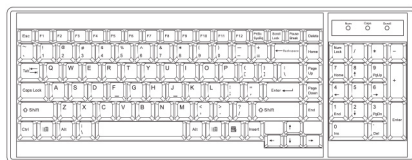

**Gb** G keyboard with trackball

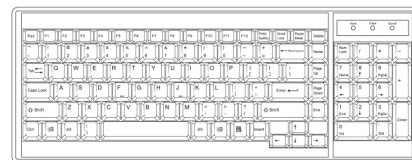

### Supporting layouts

America   
U.S.

EMEA        
U.K. Germany France Russia Spain Italy

Asia    
Japan Korea

## KEYBOARD OPTIONS

\* US layout only

**Me** Mac keyboard with touchpad



**Se** S keyboard with touchpad

**Mb** Mac keyboard with trackball

**Sb** S keyboard with trackball



## STRUCTURE DIAGRAM

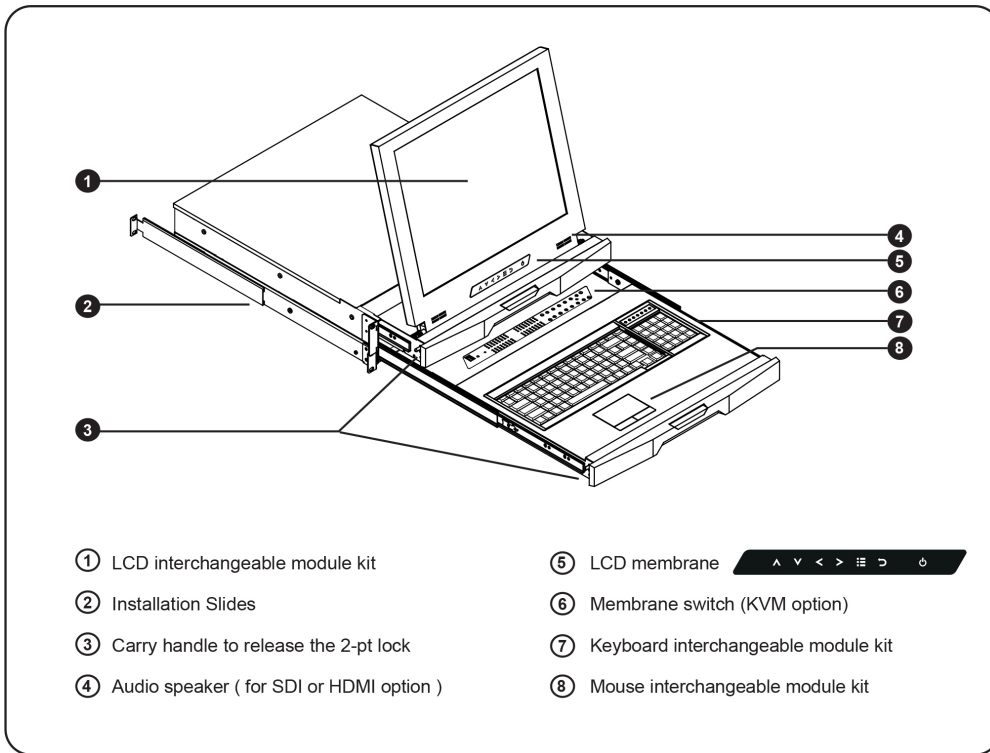

## DIMENSION

*This is subject to change without Notice. Final Drawings Will be Provided for Approval after Order.*

### Front View

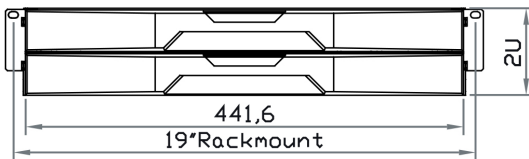

### Top View

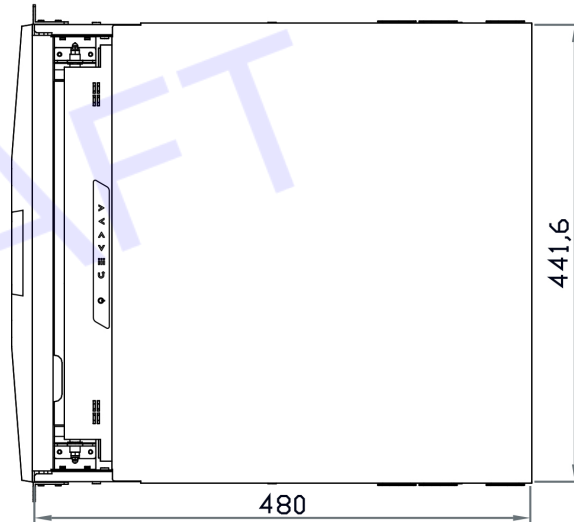

### Rear View

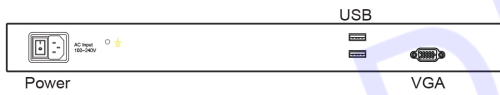

### Side View

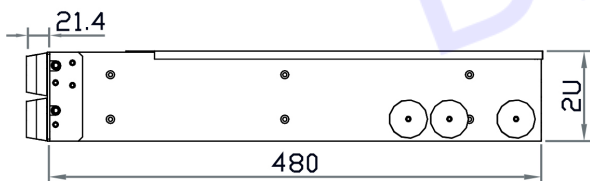

Drawing No.: NVP2417e-DVI-04272022-V1