



2U Dual Slide 17" FHD LCD Console Drawer, 1920x1080 with 8-Ports 2K HDMI USB KVM, 104-key keyboard with touchpad, unit Depth is 18.9" (48cm)  
**Include N2K-6H Cables, HDMI KVM cable, 6 ft 2K 60Hz**

**Model: NVP2417-8Ke**

### FEATURES:

- 2U 17" LED-backlit LCD console drawer
- Dual slide - LCD and keyboard slide independently
- 1920 x 1080 native resolution / 16.7M colors ( 8-bit )
- 104-key USB keyboard with either touchpad or trackball
- One Man installation design
- Enhanced aesthetics with molded front handle and two point lock
- 2-year standard warranty ( upgradable up to 5 years )

### OPTIONS

- Dual stereo speakers for HDMI ( HS4.4 )
- DP 1.0 + Speakers ( DP )
- DVI-D + Audio input & output + Speakers ( DV4.4 )
- Composite + Audio IN + Speakers ( BNC )
- 3G / HD / SD-SDI Broadcast-grade input + Speakers ( SDI )
- DC power : 12V / 24V / 48V / 125V / 250V
- SUN Micro keyboard option
- Touchscreen :  
Projected Capacitive 10-pt / Resistive 1-pt

### SPECIFICATIONS:

LCD Panel	
Panel size ( diagonal )	17.3"
Native resolution	1920 x 1080
Brightness ( cd/m <sup>2</sup> )	300
Contrast ratio ( typ. )	1000 : 1
Colors	16.7 M, 8-bit
Viewing angle ( L/R/U/D )	85/85/85/85
Response time ( ms )	5.5
Dot pitch ( mm )	0.1989
Display area ( mm )	381.888H x 214.812V
Surface treatment	Anti-glare, Hard-coating
Surface hardness	3H
Backlight type	LED
MTBF (hrs)	15,000

Mounting Distance	
Console w/ KVM drawer	490 ~ 700 mm 19.3 ~ 27.6 inch

Video Option		
Digital	DVI-D	DVI-D single link
	Display port	DP 1.0 / HDCP 1.3
Analog	Composite ( BNC )	NTSC & PAL

**\*Specifications subject to change without notice, not responsible for typographical errors.**

Environment	
Operating temp.	0 to 55°C degree
Storage temp.	-20 to 60°C degree
Operating humidity	10~90%, non-condensing
Storage humidity	5 ~90%, non-condensing
Operating altitude	16,000 ft
Non-operating altitude	40,000 ft
Shock	10G acceleration ( 11ms duration )
Vibration	10~300Hz 0.5G RMS random vibration

Compliance	
EMC	FCC & CE certified
Safety	CE / LVD certified
Environment	REACH & RoHS3 / WEEE

Physical		
Dimensions; ( W x D x H )	Console w/ KVM	442 x 480 x 88 mm 17.4 x 18.9 x 3.5 inch
Packing ( W x D x H )	Console w/ KVM	590 x 620 x 190 mm 23.2 x 24.4 x 7.5 inch
Net weight	Console w/ KVM	21.1 kg / 46.4 lb
Gross weight	Console w/ KVM	27 kg / 59.4 lb

## KVM PORT CONNECTION

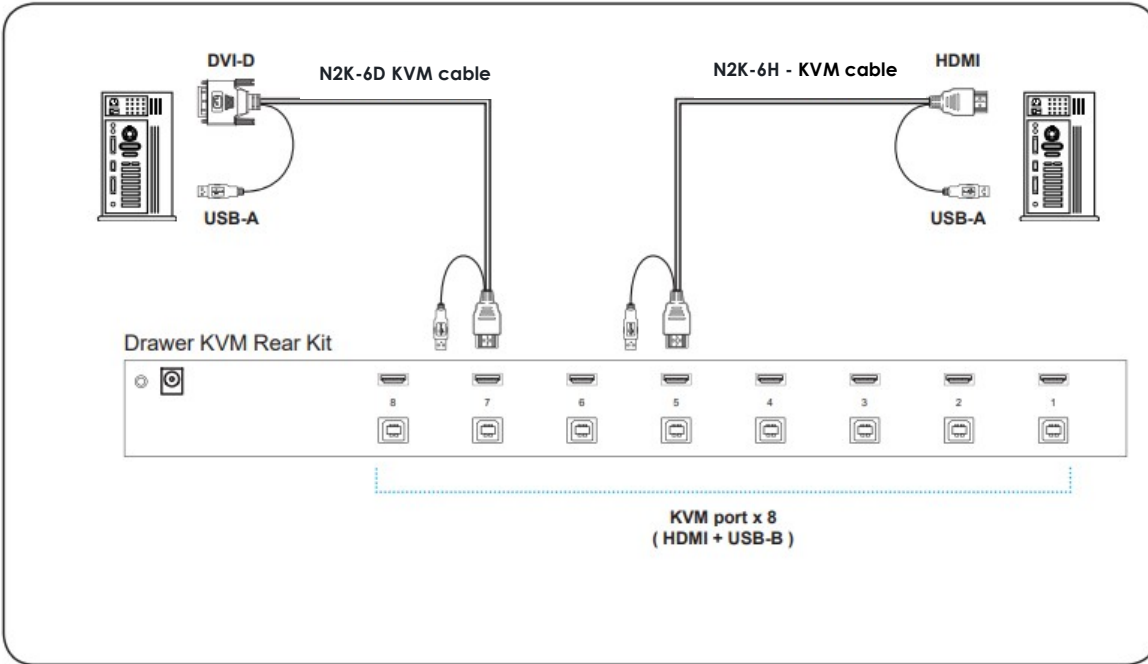

**N2K-6D** - 6 feet DVI-D KVM cable  
( Server end : DVI-D + USB-A )  
( KVM port : HDMI + USB-B )



**N2K-6H** - 6 feet HDMI KVM cable  
( Server end : HDMI + USB-A )  
( KVM port : HDMI + USB-B )

## KVM SPECIFICATIONS

<b>KVM Port</b>		
Number of ports :	8	
Connector :	HDMI 1.4 + USB-B ( Video + KB / MS )	
Resolution :	16 : 9 - max. 2560 x 1440@60Hz 16 : 10 - max. 1920 x 1200@60Hz 4 : 3 - max. 1600 x 1200@60Hz	
<b>Management</b>		
PC Selection	Front button & keyboard hotkey	
<b>Compatibility</b>		
Hardware :	HP / IBM / Dell PC, Server and Blade Server SUN / Mac	
OS Support :	Windows / Linux / Unix / Mac OS	
<b>Power</b>		
Input :	Auto sensing 100 to 240VAC, 50 / 60 Hz	
Consumption :	Max. 10W	
<b>Compliance</b>		
EMC :	FCC & CE	
Safety :	CE / LVD & UKCA	
Environment :	RoHS3 & REACH / WEEE	
<b>Environmental</b>	<b>Operating</b>	<b>Storage / Non-operating</b>
Temperature :	0 to 55°C degree	-20 to 60°C degree
Humidity :	10~90%, non-condensing	5~90%, non-condensing
Altitude :	16,000 ft	40,000 ft
Shock :	-	10G acceleration (11ms duration)
Vibration :	-	10~300Hz 0.5G RMS random vibration

## STANDARD KEYBOARD



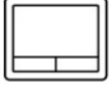





**e** keyboard integrated with touchpad



**b** keyboard integrated with trackball



### Supporting layouts

America					
	United States				
EMEA					
	United Kingdom	Germany	France	Spain	Italy
Asia					
	Japan	Korea			

## KEYBOARD OPTIONS (US layout only)

**Se** S keyboard with touchpad

**Sb** S keyboard with trackball

