

1U 17" Ultra Short Depth 4K LCD Console Drawer with 8-Ports 4K HDMI USB KVM, 104-key keyboard with trackball

Model: NVP1417-84Kb

Ultra Short Depth
400mm / 15.7"



FEATURES:

- 1U 17" 4K LCD console drawer
- 3840 x 2160@60Hz native resolution / 16.7M colors (8-bit)
- 1920 x 1080 & 1920 x 1200 resolution support
- Ideal for open rack / short depth rack
- 104-key keyboard with either touchpad or trackball
- Built-in dual stereo speakers
- One Man installation design
- Enhanced aesthetics with new molded front panel and 2-point lock
- 2-year standard warranty (upgradable up to 5 years)

SPECIFICATIONS:

LCD Panel	
Panel size (diagonal)	17.3"
Native resolution	3840 x 2160@60Hz
Brightness (cd/m ²)	400
Contrast ratio (typ.)	1000 : 1
Colors	16.7 M, 8-bit
Viewing angle (L/R/U/D)	89/89/89/89
Response time (ms)	16
Dot pitch (mm)	0.0995
Display area (mm)	382.12H x 214.94V
Surface treatment	Anti-glare
Surface hardness	3H
Backlight type	LED
MTBF (hrs)	15,000

Mounting Distance	
Console w/ KVM drawer	410 ~ 800 mm 16.1 ~ 31.5 inch

Video Option		
Digital	HDMI	HDMI 2.0 / HDCP 2.2

OPTIONS

- HDMI 2.0 video input
- Front USB Hub Port for Device Access
- 3G / HD / SD-SDI Broadcast-grade input
- DC power : 12V / 24V / 48V / 125V
- MAC or SUN Micro keyboard options available
- Touchscreen : Resistive 1-pt

Power		
Input	Auto-sensing 100 to 240VAC, 50 / 60Hz	
Consumption (console / KVM)	Screen on	Max. 21W / Max. 38W
	Power saving mode	Max. 2W / Max. 18W
	Power button on	Max. 1W / Nil

Environment	
Operating temp.	0 to 55°C degree
Storage temp.	-20 to 60°C degree
Operating humidity	20~90%, non-condensing
Storage humidity	5 ~90%, non-condensing
Operating altitude	16,000 ft
Non-operating altitude	40,000 ft
Shock	10G acceleration (11ms duration)
Vibration	10~300Hz 0.5G RMS random vibration

Compliance	
EMC	FCC & CE certified
Safety	CE / LVD certified
Environment	RoHS2 & REACH compliant

Physical		
Dimensions; (W x D x H)	Console w/ KVM	442 x 580 x 44 mm 17.4 x 22.8 x 1.73 inch
	Packing (W x D x H)	590 x 808 x 140 mm 23.2 x 31.8 x 5.5 inch
Net weight	Console w/ KVM	9.5 kg / 20.9 lb
Gross Weight	Console w/ KVM	16.1 kg / 35.4 lb

***Specifications subject to change without notice, not responsible for typographical errors.**

BENIFITS

- 4K KVM with 8 HDMI USB ports in 1U
- 4K KVM cables support DP & HDMI video input
- USB hub port share peripheral devices among computers
- Local console & KVM ports support resolution 4K, 2K and 1080p.
- Multi-platform for PC, server, blade server & SUN / MAC
- Port switching via front button & keyboard hotkeys
- Hot pluggable, no software or drivers required

4K KVM Cable



NK6DP
DP KVM cable
6ft 4K 60Hz



NK6H
HDMI KVM cable
6ft 4K 60Hz

OPTIONS

DC power options: 12V / 24V / 48V / 125V

KVM Port	
Port # :	8
Connector :	HDMI 2.0 + USB-B (Video + KB / MS)
Resolution :	16 : 9 - max. 3840 x 2160@60Hz
	16 : 10 - max. 1920 x 1200@60Hz
	4 : 3 - max. 1600 x 1200@60Hz

Local Console	
Keyboard / Mouse :	2 x USB-A
Video :	1 x HDMI 2.0
Resolution :	16 : 9 - max. 3840 x 2160@60Hz
	16 : 10 - max. 1920 x 1200@60Hz
	4 : 3 - max. 1600 x 1200@60Hz

LOCAL CONSOLE & KVM PORT CONNECTION

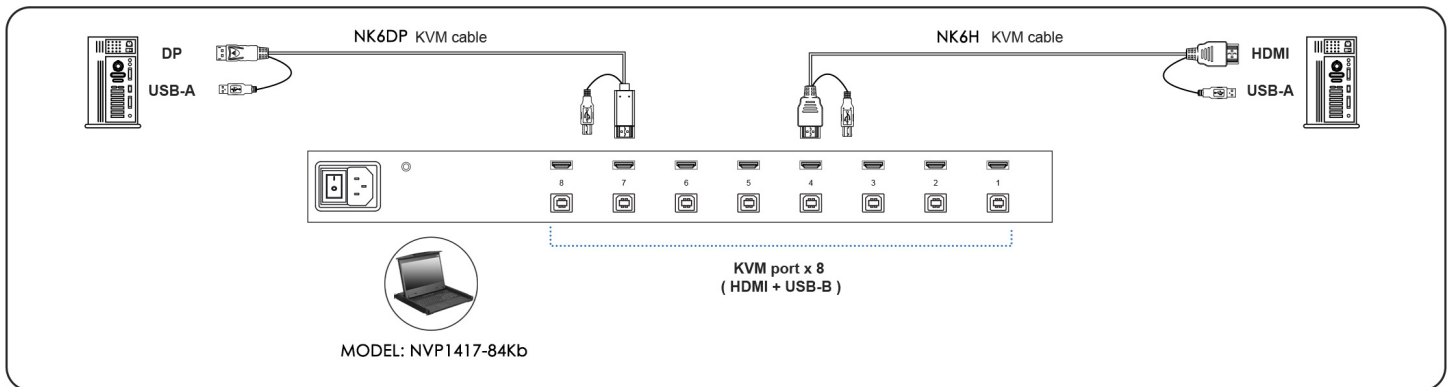

Management	
Port switching	Front button & keyboard hotkeys
Compatibility	
Hardware	HP / IBM / Dell PC, Server and Blade Server SUN / Mac
OS support	Windows / Linux / Unix / Mac OS
Environment	
Operating temp.	0 to 55°C degree
Storage temp.	-20 to 60°C degree
Operating humidity	20~90%, non-condensing
Operating altitude	16,000 ft
Non-operating altitude	40,000 ft
Shock	10G acceleration (11ms duration)
Vibration	10~300Hz 0.5G RMS random vibration

Power	
Input	Auto-sensing 100 to 240VAC, 50 / 60Hz
Consumption	Max. 10W
Compliance	
Safety	FCC & CE certified
Environment	RoHS2 & REACH compliant

STANDARD KEYBOARD



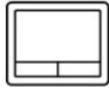











e keyboard integrated with touchpad



b keyboard integrated with trackball



Supporting layouts

America	 United States				
EMEA	 United Kingdom	 Germany	 France	 Spain	 Norway
	 Italy	 Russia	 Switzerland	 Netherlands	 Portugal
Asia	 China	 Japan	 Korea	 Arabia	 Turkey

KEYBOARD OPTIONS (US layout only)

Me Mac keyboard with touchpad



Mb Mac keyboard with trackball

Se S keyboard with touchpad

Sb S keyboard with trackball

