



1U 23" LCD Console Drawer with 4K 3840x2160 Native Resolution, DP Video Input with Touchpad (e) (KB & MS) Attached 6ft DP cable + USB-A to USB-A x 2

Model: NVP1240Ke

FEATURES:

- 1U 23" 4K LCD console drawer
- 3840 x 2160@60Hz native resolution / 1.07B colors (10-bit)
- 1920 x 1080 & 1920 x 1200 resolution support
- Display port 1.2 video input / USB KB/MS
- 104-key keyboard with either touchpad or trackball
- Built-in dual stereo speakers
- One Man installation design
- Enhanced aesthetics with new molded front panel and 2-point lock
- 2-year standard warranty (upgradable up to 5 years)

OPTIONS

- Front USB hub port for device access
- HDMI 2.0 video input
- 3G / HD / SD-SDI Broadcast-grade input
- DC power : 12V / 24V / 48V / 125V
- MAC or SUN Micro keyboard options available
**with 2 x USB cable for keyboard & mouse.*

SPECIFICATIONS:

Console Port	
Video input attached 6ft DP cable	Display port 1.2
KB / MS bundled 6ft cable x2	USB type A

LCD Panel	
Panel size (diagonal)	23.8"
Native resolution	3840 x 2160 @60Hz
Brightness (cd/m ²)	310
Contrast ratio (typ.)	1000 : 1
Colors	1.07 Billion, 10-bit
Viewing angle (L/R/U/D)	89/89/89/89
Response time (ms)	25
Dot pitch (mm)	0.13725
Display area (mm)	527.04H x 296.46V
Surface treatment	Anti-glare
Surface hardness	3H
Backlight type	LED
MTBF (hrs)	30,000

Audio Option		
Output	Connector	3.5mm stereo jack
	Resistance / Power level	30kQΩ / 2.8V
Speaker	Dual stereo	2W x 2

Mounting Distance	
Single console drawer	670 ~ 900 mm 26.4 ~ 35.4 inch
Console w/ KVM drawer	670 ~ 980 mm 26.4 ~ 38.6 inch

Video Option		
Digital	HDMI	HDMI 2.0 / HDCP 2.2

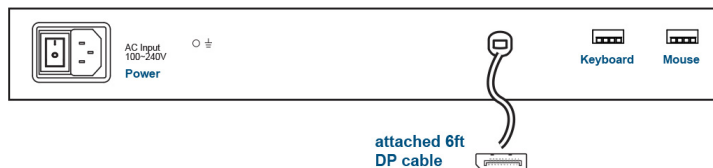

Power		
Input	Auto-sensing 100 to 240VAC, 50 / 60Hz	
Consumption (console / KVM)	Screen on	Max. 43W / Max. 54W
	Power saving mode	Max. 2W / Max. 18W
	Power button off	Max. 1W / Nil

Environment	
Operating temp.	0 to 55°C degree
Storage temp.	-20 to 60°C degree
Operating humidity	20~90%, non-condensing
Storage humidity	5 ~90%, non-condensing
Operating altitude	16,000 ft
Non-operating altitude	40,000 ft
Shock	10G acceleration (11ms duration)
Vibration	10~300Hz 0.5G RMS random vibration

Compliance	
EMC	FCC & CE
Safety	CE / LVD & UKCA
Environment	RoHS3 & REACH

Physical		
Dimensions; (W x D x H)	Single console	442 x 690 x 44 mm 17.4 x 27.2 x 1.73 inch
	Console w/ KVM	442 x 750 x 44 mm 17.4 x 29.5 x 1.73 inch
Packing (W x D x H)	Single console / Console w/ KVM	590 x 965 x 136 mm 23.2 x 38 x 5.4 inch
	Net weight	Single console
Console w/ KVM		16.1kg / 35.4 lb
Gross Weight	Single console	19.5 kg / 42.9 lb
	Console w/ KVM	22 kg / 48.4 lb

NVP1240K MODELS W/ KVM

40 6Hz KVM	IP	Remote	8-port
	0	0	NVP1240-801K

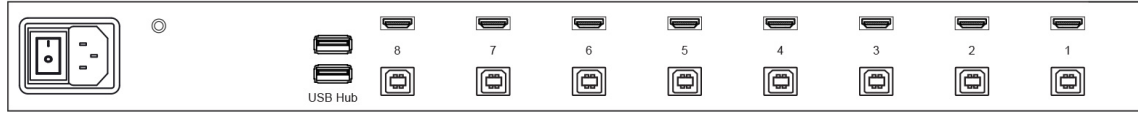

4K KVM Cable

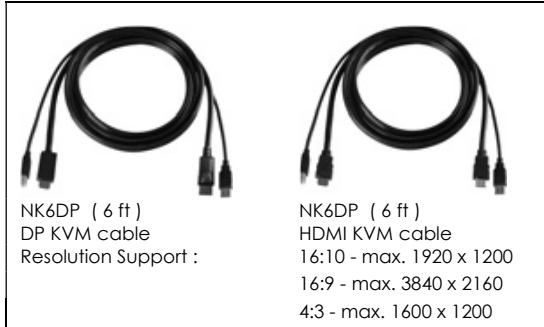

STANDARD KEYBOARD

Ge G keyboard with touchpad

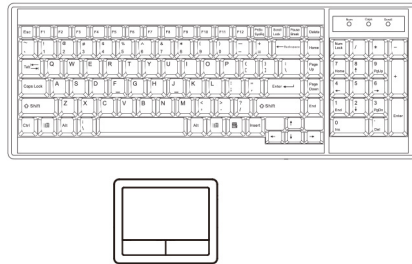

Gb G keyboard with trackball



Supporting layouts

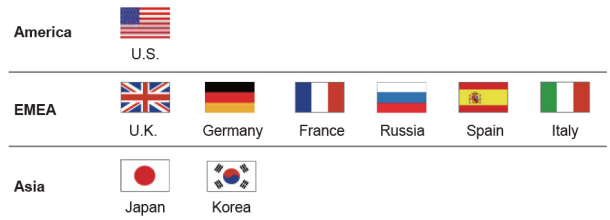

KEYBOARD OPTIONS

* US layout only

Me Mac keyboard with touchpad



Mb Mac keyboard with trackball

Se S keyboard with touchpad

Sb S keyboard with trackball



STRUCTURE DIAGRAM

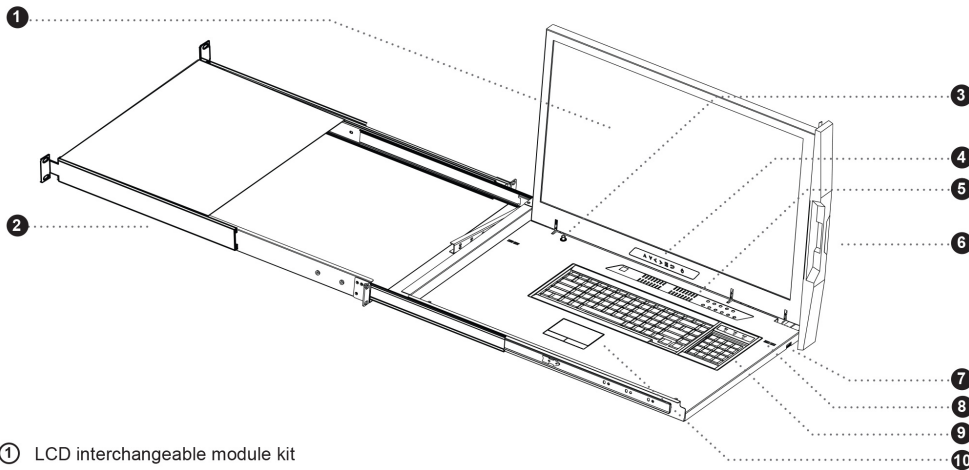

- ① LCD interchangeable module kit
- ② Installation Slides
- ③ Micro switch for screen auto power off
- ④ LCD membrane 
- ⑤ Membrane switch (KVM option)
- ⑥ Carry handle to release the 2-pt lock
- ⑦ Front USB port for device access (USB Hub KVM only)
- ⑧ Audio speaker (for SDI or HDMI option)
- ⑨ Keyboard interchangeable module kit
- ⑩ Mouse interchangeable module kit

DIMENSION

This is subject to change without Notice. Final Drawings Will be Provided for Approval after Order.

Front View

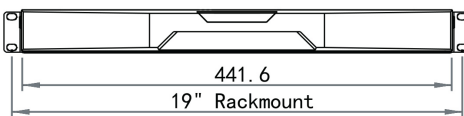

Rear View

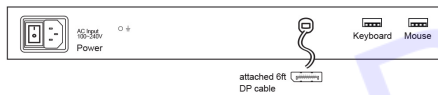

Side View

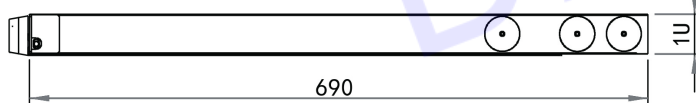

Top View

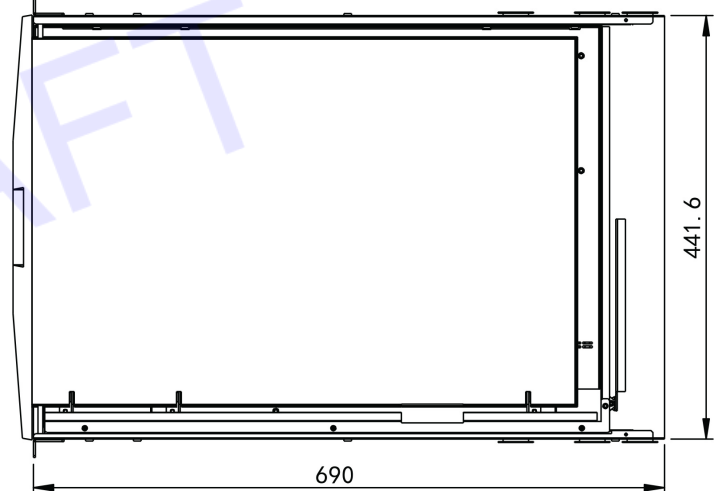

Drawing No.: NVP1240Ke -05092022-V1

ACTUAL PICTURES

