

# NVP Series 4K

## 1U Rack Mount 4K LCD Console Drawer

1U 23" LCD Console Drawer With 4K 3840x2160 Native Resolution Touchpad DP (1.2) + Speakers, 2 x USB (KB & MS) Attached 6ft DP cable + USB-A to USB-A x2 Right side open



Model: NVP1240Ke-R

### FEATURES:

- 1U 23" 4K LED-backlit LCD console drawer
- Native resolution of 3840 x 2160@60Hz / 1.07 billion colors (10-bit)
- Supports QHD resolution of 2560 x 1440@60Hz
- Also supports resolutions of 1920 x 1080 and 1920 x 1200
- Video input via DisplayPort 1.2 / USB keyboard and mouse
- Includes a 104-key USB keyboard with a touchpad
- Equipped with built-in dual stereo speakers
- Designed for easy installation by one person
- Features enhanced aesthetics with a newly molded front panel and a 2-point lock
- Comes with a standard 2-year warranty (upgradable to 5 years)

### OPTIONS

- HDMI 2.0 video input ( HDMI )
- 3G / HD / SD-SDI Broadcast-grade input ( SDI )
- Front USB hub port for device access ( USB )
- DC power : 12V / 24V / 48V / 125V / 250V
- SUN Micro keyboard option

### SPECIFICATIONS:

Console Port	
Video input attached 6ft DP cable	Display port 1.2
KB / MS bundled 6ft cable x2	USB type A

LCD Panel	
Panel size ( diagonal )	23.8"
Native resolution	3840 x 2160 @60Hz
Brightness ( cd/m <sup>2</sup> )	310
Contrast ratio ( typ. )	1000 : 1
Colors	1.07 Billion, 10-bit
Viewing angle ( L/R/U/D )	89/89/89/89
Response time ( ms )	25
Dot pitch ( mm )	0.13725
Display area ( mm )	527.04H x 296.46V
Surface treatment	Anti-glare
Surface hardness	3H
Backlight type	LED
MTBF (hrs)	30,000

Mounting Distance	
Single console drawer	670 ~ 900 mm 26.4 ~ 35.4 inch
Console w/ KVM drawer	670 ~ 980 mm 26.4 ~ 38.6 inch

Video Option		
Digital	HDMI	HDMI 2.0 / HDCP 2.2

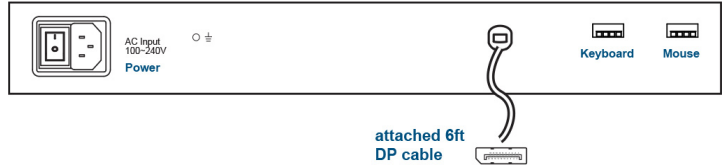

Power		
Input	Auto-sensing 100 to 240VAC, 50 / 60Hz	
Consumption (console / KVM)	Screen on	Max. 43W / Max. 54W
	Power saving mode	Max. 2W / Max. 18W
	Power button off	Max. 1W / Nil

Environment	
Operating temp.	0 to 55°C degree
Storage temp.	-10 to 60°C degree
Operating humidity	20~90%, non-condensing
Storage humidity	5 ~90%, non-condensing
Operating altitude	16,000 ft
Non-operating altitude	40,000 ft
Shock	10G acceleration ( 11ms duration )
Vibration	10~300Hz 0.5G RMS random vibration

Compliance	
EMC	FCC & CE
Safety	CE / LVD & UKCA
Environment	RoHS3 & REACH

Physical		
Dimensions; ( W x D x H )	Single console	442 x 690 x 44 mm 17.4 x 27.2 x 1.73 inch
	Console w/ KVM	442 x 750 x 44 mm 17.4 x 29.5 x 1.73 inch
Packing ( W x D x H )	Single console / Console w/ KVM	590 x 965 x 136 mm 23.2 x 38 x 5.4 inch
	Net weight	Single console
Console w/ KVM		16.1kg / 35.4 lb
Gross Weight	Single console	19.5 kg / 42.9 lb
	Console w/ KVM	22 kg / 48.4 lb

## NVP1240K MODELS W/ KVM

<b>40 6Hz KVM</b>	<b>IP</b>	<b>Remote</b>	<b>8-port</b>
	0	0	NVP1240-801K

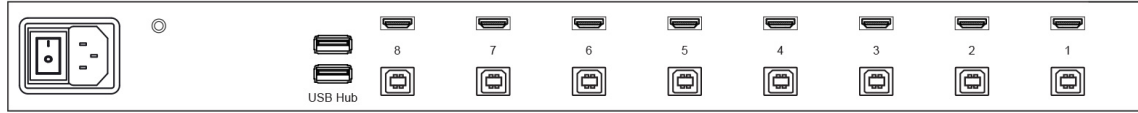

### 4K KVM Cable

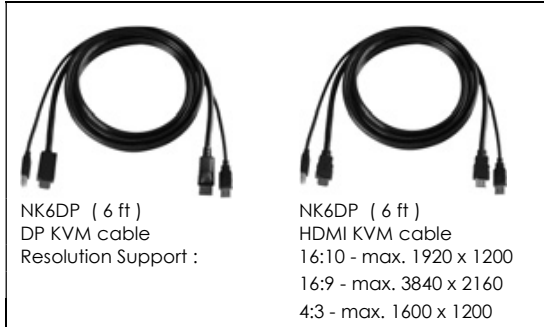

### STANDARD KEYBOARD

**Ge** G keyboard with touchpad

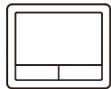
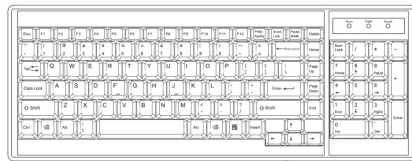

**Gb** G keyboard with trackball

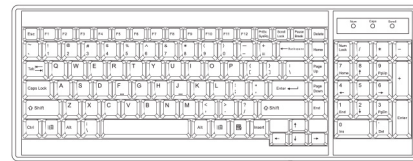

#### Supporting layouts

<b>America</b>		U.S.
<b>EMEA</b>		U.K. Germany France Russia Spain Italy
<b>Asia</b>		Japan Korea

### KEYBOARD OPTIONS \*US layout only

**Se** S keyboard with touchpad

**Sb** S keyboard with trackball



## STRUCTURE DIAGRAM

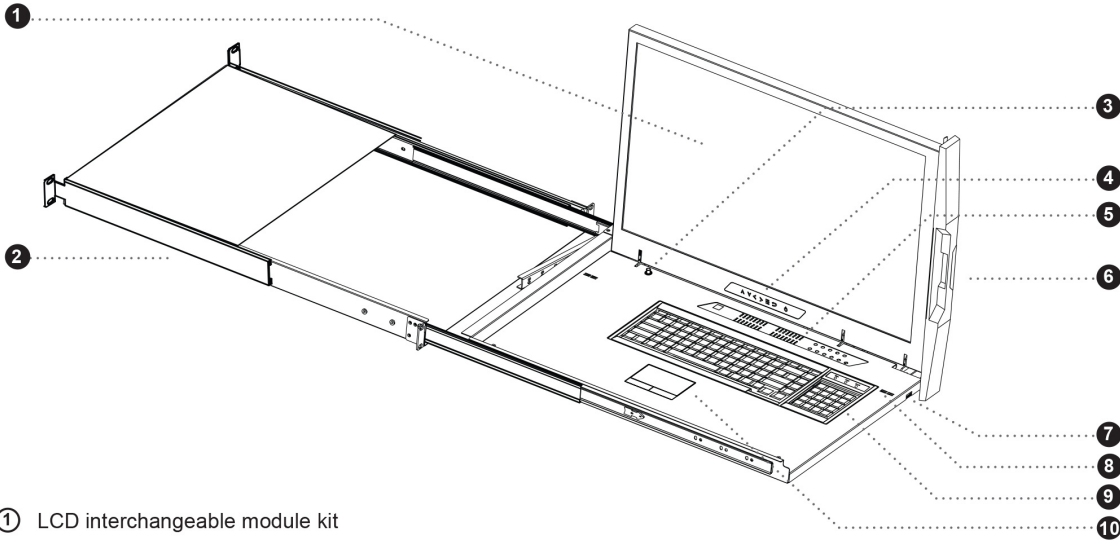

- ① LCD interchangeable module kit
- ② Installation Slides
- ③ Micro switch for screen auto power off
- ④ LCD membrane 
- ⑤ Membrane switch (KVM option)
- ⑥ Carry handle to release the 2-pt lock
- ⑦ Front USB port for device access ( USB Hub KVM only )
- ⑧ Audio speaker ( for SDI or HDMI option )
- ⑨ Keyboard interchangeable module kit
- ⑩ Mouse interchangeable module kit

## DIMENSION

*This is subject to change without Notice. Final Drawings Will be Provided for Approval after Order.*

### Front View

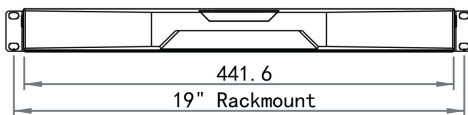

### Rear View

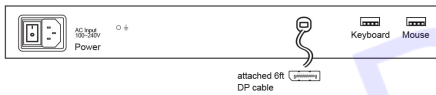

### Side View

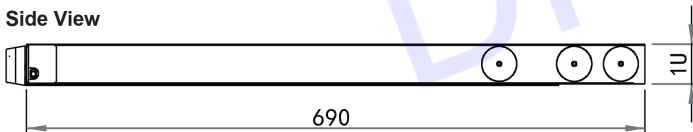

### Top View

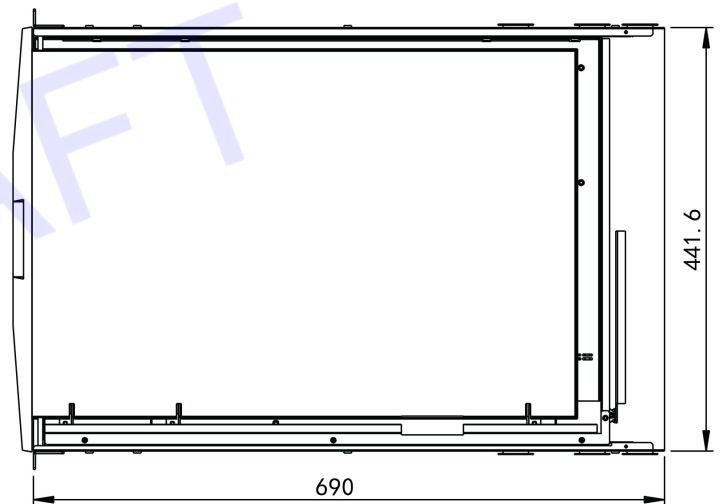

Drawing No.: NVP1240Ke-R-03282024-V1