



1U 23" 4K LCD Console Drawer with 8-Ports 4K HDMI USB KVM, 104-key keyboard with trackball

Model: NVP1240-84Kb

**FEATURES:**

- 1U 23" 4K LCD console drawer
- 3840 x 2160@60Hz native resolution / 1.07B colors ( 10-bit )
- 1920 x 1080 & 1920 x 1200 resolution support
- 104-key keyboard with either touchpad or trackball
- Built-in dual stereo speakers
- One Man installation design
- Enhanced aesthetics with new molded front panel and 2-point lock
- 2-year standard warranty ( upgradable up to 5 years )

**OPTIONS**

- HDMI 2.0 video input
- Front USB Hub Port for Device Access
- 3G / HD / SD-SDI Broadcast-grade input
- DC power : 12V / 24V / 48V / 125V
- MAC or SUN Micro keyboard options available

**SPECIFICATIONS:**

LCD Panel	
Panel size ( diagonal )	23.8"
Native resolution	3840 x 2160 @60Hz
Brightness ( cd/m <sup>2</sup> )	310
Contrast ratio ( typ. )	1000 : 1
Colors	1.07 Billion, 10-bit
Viewing angle ( L/R/U/D )	89/89/89/89
Response time ( ms )	25
Dot pitch ( mm )	0.13725
Display area ( mm )	527.04H x 296.46V
Surface treatment	Anti-glare
Surface hardness	3H
Backlight type	LED
MTBF (hrs)	30,000

Audio Option		
Output	Connector	3.5mm stereo jack
	Resistance / Power level	30kQΩ / 2.8V
Speaker	Dual stereo	2W x 2

Mounting Distance	
Console w/ KVM drawer	670 ~ 980 mm 26.4 ~ 38.6 inch

Power		
Input	Auto-sensing 100 to 240VAC, 50 / 60Hz	
Consumption (console / KVM)	Screen on	Max. 43W / Max. 54W
	Power saving mode	Max. 2W / Max. 18W
	Power button off	Max. 1W / Nil

Environment	
Operating temp.	0 to 55°C degree
Storage temp.	-20 to 60°C degree
Operating humidity	20~90%, non-condensing
Storage humidity	5 ~90%, non-condensing
Operating altitude	16,000 ft
Non-operating altitude	40,000 ft
Shock	10G acceleration ( 11ms duration )
Vibration	10~300Hz 0.5G RMS random vibration

Compliance	
EMC	FCC & CE certified
Safety	CE / LVD certified
Environment	RoHS2 & REACH compliant

Physical		
Dimensions; ( W x D x H )	Console w/ KVM	442 x 750 x 44 mm 17.4 x 29.5 x 1.73 inch
Packing ( W x D x H )	Console w/ KVM	595 x 910 x 140 mm 23.4 x 35.8 x 5.5 inch
Net weight	Console w/ KVM	16.1kg / 35.4 lb
Gross Weight	Console w/ KVM	22 kg / 48.4 lb

*\*Specifications subject to change without notice, not responsible for typographical errors.*

## BENIFITS

- 4K KVM with 8 HDMI USB ports in 1U
- 4K KVM cables support DP & HDMI video input
- USB hub port share peripheral devices among computers
- Local console & KVM ports support resolution 4K, 2K and 1080p.
- Multi-platform for PC, server, blade server & SUN / MAC
- Port switching via front button & keyboard hotkeys
- Hot pluggable, no software or drivers required

## 4K KVM Cable



**NK6DP**  
DP KVM cable  
6ft 4K 60Hz



**NK6H**  
HDMI KVM cable  
6ft 4K 60Hz

## OPTIONS

DC power options: 12V / 24V / 48V / 125V

KVM Port	
Port # :	8
Connector :	HDMI 2.0 + USB-B ( Video + KB / MS )
Resolution :	16 : 9 - max. 3840 x 2160@60Hz
	16 : 10 - max. 1920 x 1200@60Hz
	4 : 3 - max. 1600 x 1200@60Hz

Local Console	
Keyboard / Mouse :	2 x USB-A
Video :	1 x HDMI 2.0
Resolution :	16 : 9 - max. 3840 x 2160@60Hz
	16 : 10 - max. 1920 x 1200@60Hz
	4 : 3 - max. 1600 x 1200@60Hz

## LOCAL CONSOLE & KVM PORT CONNECTION

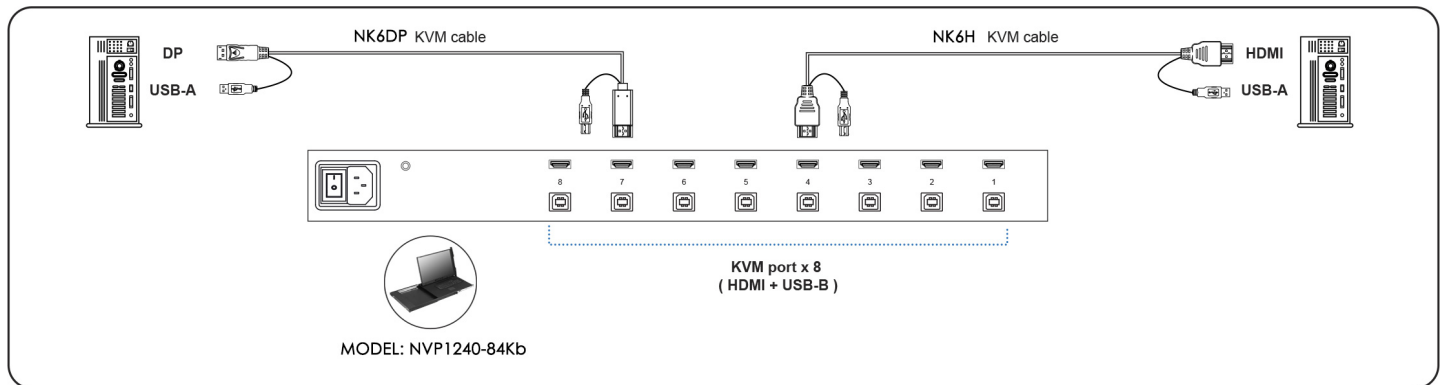

Management	
Port switching	Front button & keyboard hotkeys
Compatibility	
Hardware	HP / IBM / Dell PC, Server and Blade Server SUN / Mac
OS support	Windows / Linux / Unix / Mac OS
Environment	
Operating temp.	0 to 55°C degree
Storage temp.	-20 to 60°C degree
Operating humidity	20~90%, non-condensing
Operating altitude	16,000 ft
Non-operating altitude	40,000 ft
Shock	10G acceleration ( 11ms duration )
Vibration	10~300Hz 0.5G RMS random vibration

Power	
Input	Auto-sensing 100 to 240VAC, 50 / 60Hz
Consumption	Max. 10W
Compliance	
Safety	FCC & CE certified
Environment	RoHS2 & REACH compliant

## STANDARD KEYBOARD



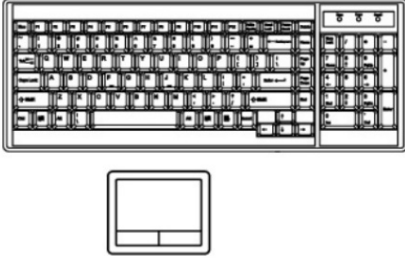













**e** keyboard integrated with touchpad



**b** keyboard integrated with trackball



### Supporting layouts

America	 United States				
EMEA	 United Kingdom	 Germany	 France	 Spain	 Norway
	 Italy	 Russia	 Switzerland	 Netherlands	 Portugal
Asia	 China	 Japan	 Korea	 Arabia	 Turkey

## KEYBOARD OPTIONS (US layout only)

**Me** Mac keyboard with touchpad



**Se** S keyboard with touchpad

**Mb** Mac keyboard with trackball

**Sb** S keyboard with trackball

