

1U Rackmount 19" TFT LCD Monitor w/ Notebook Keyboard & Touchpad mouse Drawer 1280x1024. VGA Input Include NB-6A VGA+ 2xUSB KVM combo Cable 6ft long. 19.7" DEEP CHASSIS

MODEL: NVP119e



BENEFITS:

- 1U 19" LCD console drawer
- 1280 x 1024 native resolution / 16.7M colors
- 104-key keyboard with either touchpad or trackball
- Short depth design of 460mm and 500mm respectively
- One Man installation design
- New enhanced aesthetics with molded front handle
- 2-year standard warranty (upgradable up to 5 years)
- TAA Compliant

OPTIONS:

- HDMI 1.4 + DVI-D + Audio in & out + Speakers (AV4.4)
- HDMI 1.4 + Speakers (HDMI)
- S-Video + Composite + Speakers (BNC)
- 3G / HD / SD-SDI Broadcast-grade input + Speakers (SDI)
- Front USB hub port for device access (USB)
- 2-post rack mounting brackets (ORB-2.1)
- DC power : 12V / 24V / 48V / 125V / 250V
- SUN Micro keyboard option
- 19" Touchscreen : Resistive 1-pt

SPECIFICATIONS

Console Port	
Video input	VGA
KB / MS	USB interface
VGA console 6ft cable : NB-6A	Drawer end : DB-15 + USB type A x 2 Server end : DB-15 + USB type A x 2

LCD Panel	
Panel size (diagonal)	19"
Native resolution	1280 x 1024
Brightness (cd/m ²)	250
Contrast ratio (typ.)	1000 : 1
Colors	16.7 M
Viewing angle (L/R/U/D)	85/85/80/80
Response time (ms)	5
Dot pitch (mm)	0.264
Display area (mm)	376.32H x 301.06V
Surface treatment	Haze 25%, Hard-coating
Surface hardness	3H
Backlight type	LED
MTBF (hrs)	30,000

Physical		
Product (W x D x H)	Single console	442 x 500 x 44 mm 17.4 x 19.7 x 1.73 inch
	Console w/ KVM	442 x 620 x 44 mm 17.4 x 24.4 x 1.73 inch
Packing (W x D x H)	Single console / Console w/ KVM	590 x 815 x 140 mm 23.2 x 32.1 x 5.5 inch
	Single console	12.7 kg / 27.9 lb
Net weight	Console w/ KVM	13.7 kg / 30.1 lb
	Single console	17.3 kg / 38.1 lb
Gross weight	Single console	17.3 kg / 38.1 lb
	Console w/ KVM	19.7 kg / 43.3 lb

Mounting Distance	
Single console drawer	510 ~ 740 mm 20.1 ~ 29.1 inch
Console w/ KVM drawer	510 ~ 840 mm 20.1 ~ 33.1 inch

**Specifications subject to change without notice, not responsible for typographical errors.*

Video Option		
Digital	DVI	DVI-D single link
	HDMI	HDMI 1.4 / HDCP 1.4
Analog	S-Video (4-pin)	NTSC & PAL
	Composite (BNC)	NTSC & PAL

HDMI

NVP119 chassis extension in depth to 520mm (20.5")

S-Video & Composite

NVP119 chassis extension in depth to 570mm (22.4")

Audio Option		
Input	Connector	3.5mm stereo jack
	Impedance / Power level	30kΩ / 750mV
Output	Connector	3.5mm stereo jack
	Resistance / Power level	30kΩ / 2.8V
Speaker	Dual stereo	2W x 2

Power		
Input	Auto-sensing 100 to 240VAC, 50 / 60Hz	
Consumption (console / KVM)	Screen on	Max. 22W / Max. 55W
	Power saving mode	Max. 2W / Max. 34W
	Power button off	Max. 1W / Nil

Environment	
Operating temp.	-20 to 65°C degree
Storage temp.	-20 to 65°C degree
Operating humidity	10~90%, non-condensing
Storage humidity	5 ~90%, non-condensing
Operating altitude	16,000 ft
Non-operating altitude	40,000 ft
Shock	10G acceleration (11ms duration)
Vibration	10~300Hz 0.5G RMS random vibration

Compliance	
EMC	FCC, CE certified
Safety	CE / LVD, UKCA & CCC
Environment	RoHS3 & REACH / WEEE

STANDARD KEYBOARD



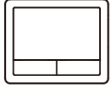





Ge G keyboard with touchpad



Gb G keyboard with trackball



Supporting layouts

America						
	U.S.					
EMEA						
	U.K.	Germany	France	Russia	Spain	Italy
Asia						
	Japan	Korea				

KEYBOARD OPTIONS

* US layout only

Se S keyboard with touchpad



Sb S keyboard with trackball

STRUCTURE DIAGRAM

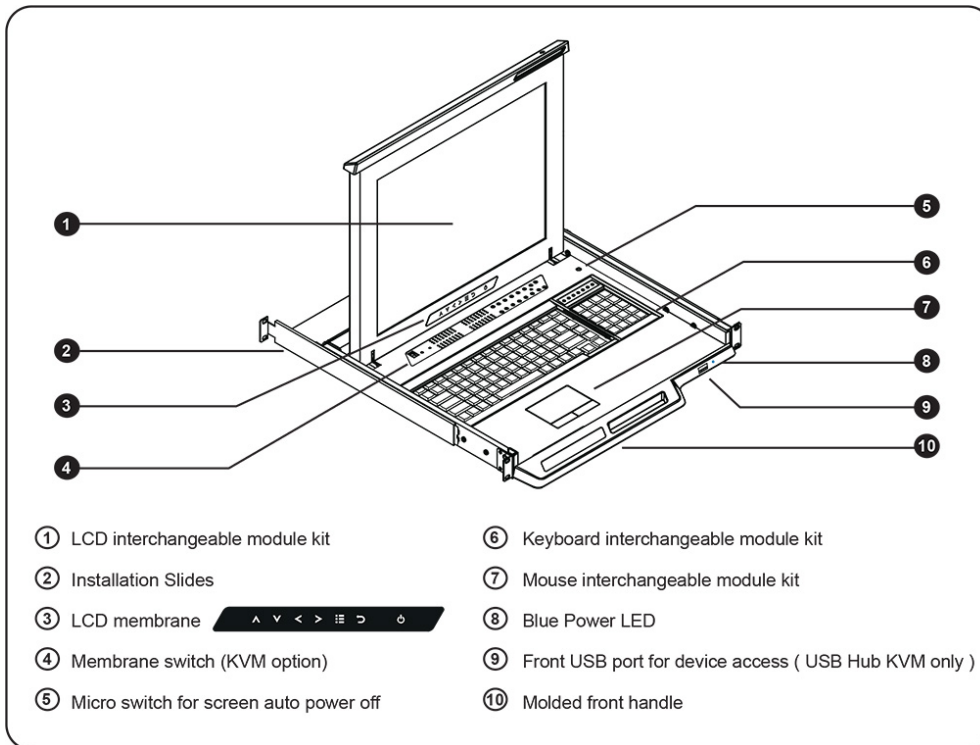

DIMENSION

This is subject to change without Notice. Final Drawings Will be Provided for Approval after Order.

Front View

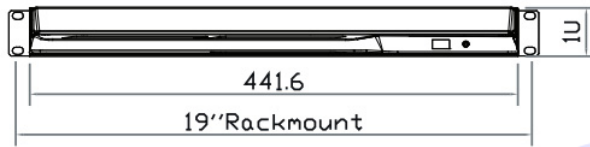

Rear View

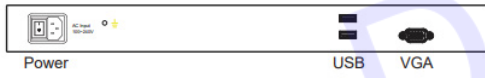

Side View

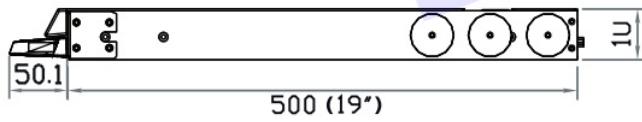

Top View

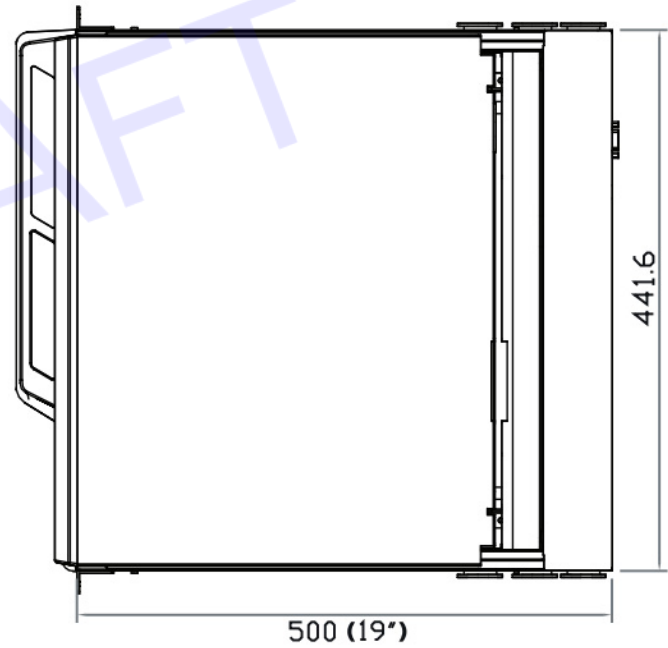

Drawing No.: NVP119e-05282024-V1

ACTUAL PICTURES

