

1U Rackmount 19" TFT LCD Monitor w/ Notebook Keyboard & Touch-pad
 Mouse Drawer 1280x1024 Res. VGA Input Include NB-6A VGA+ 2xUSB
 KVM Combo Cable 6ft long.

Integrated 19" e-Resistive Touch Screen with USB Controller.
 Unit Depth: 22.5" / Mounting Distance: 19.7" ~ 30.5" (w/ 16" Mounting Bracket)

MODEL: NVP119e-TSR-USB



BENEFITS:

- 1U 19" LCD console drawer
- Native resolution: 1280 x 1024, supporting 16.7M colors
- 104-key keyboard with optional touchpad or trackball
- Designed for easy one-person installation
- Upgraded aesthetics with a molded front handle
- Standard 2-year warranty, extendable up to 5 years
- TAA compliant

OPTIONS:

- HDMI 1.4 + DVI-D + Audio in & out + Speakers (AV4.4)
- HDMI 1.4 + Speakers (HDMI)
- S-Video + Composite + Speakers (BNC)
- 3G / HD / SD-SDI Broadcast-grade input + Speakers (SDI)
- Front USB hub port for device access (USB)
- 2-post rack mounting brackets (ORB-2.1)
- DC power : 12V / 24V / 48V / 125V / 250V
- SUN Micro keyboard option
- 19" Touchscreen : Resistive 1-pt

SPECIFICATIONS

Console Port	
Video input	VGA
KB / MS	USB interface
VGA console 6ft cable : NB-6A	Drawer end : DB-15 + USB type A x 2 Server end : DB-15 + USB type A x 2

LCD Panel	
Panel size (diagonal)	19"
Native resolution	1280 x 1024
Brightness (cd/m ²)	250
Contrast ratio (typ.)	1000 : 1
Colors	16.7 M
Viewing angle (L/R/U/D)	85/85/80/80
Response time (ms)	5
Dot pitch (mm)	0.264
Display area (mm)	376.32H x 301.06V
Surface treatment	Haze 25%, Hard-coating
Surface hardness	3H
Backlight type	LED
MTBF (hrs)	30,000

Physical		
Product (W x D x H)	Single console	442 x 572 x 44 mm 17.4 x 22.5 x 1.73 inch
Packing (W x D x H)	Single console	590 x 815 x 140 mm 23.2 x 32.1 x 5.5 inch
Net weight	Single console	12.7 kg / 27.9 lb
Gross weight	Single console	17.3 kg / 38.1 lb

Mounting Distance	
Single console drawer	500 ~ 775 mm 19.7 ~ 30.5 inch

*Specifications subject to change without notice, not responsible for typographical errors.

Video Option		
Digital	DVI	DVI-D single link
	HDMI	HDMI 1.4 / HDCP 1.4
Analog	S-Video (4-pin)	NTSC & PAL
	Composite (BNC)	NTSC & PAL

HDMI

NVP119 chassis extension in depth to 520mm (20.5")

S-Video & Composite

NVP119 chassis extension in depth to 570mm (22.4")

Audio Option		
Input	Connector	3.5mm stereo jack
	Impedance / Power level	30kQ / 750mV
Output	Connector	3.5mm stereo jack
	Resistance / Power level	30kQ / 2.8V
Speaker	Dual stereo	2W x 2

Power		
Input	Auto-sensing 100 to 240VAC, 50 / 60Hz	
Consumption (console / KVM)	Screen on	Max. 22W / Max. 55W
	Power saving mode	Max. 2W / Max. 34W
	Power button off	Max. 1W / Nil

Environment	
Operating temp.	-20 to 65°C degree
Storage temp.	-20 to 65°C degree
Operating humidity	10~90%, non-condensing
Storage humidity	5~90%, non-condensing
Operating altitude	16,000 ft
Non-operating altitude	40,000 ft
Shock	10G acceleration (11ms duration)
Vibration	10~300Hz 0.5G RMS random vibration

Compliance	
EMC	FCC, CE certified
Safety	CE / LVD, UKCA & CCC
Environment	RoHS3 & REACH / WEEE

STANDARD KEYBOARD



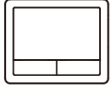





Ge G keyboard with touchpad



Gb G keyboard with trackball



Supporting layouts

America						
	U.S.					
EMEA						
	U.K.	Germany	France	Russia	Spain	Italy
Asia						
	Japan	Korea				

KEYBOARD OPTIONS

* US layout only

Se S keyboard with touchpad



Sb S keyboard with trackball

STRUCTURE DIAGRAM

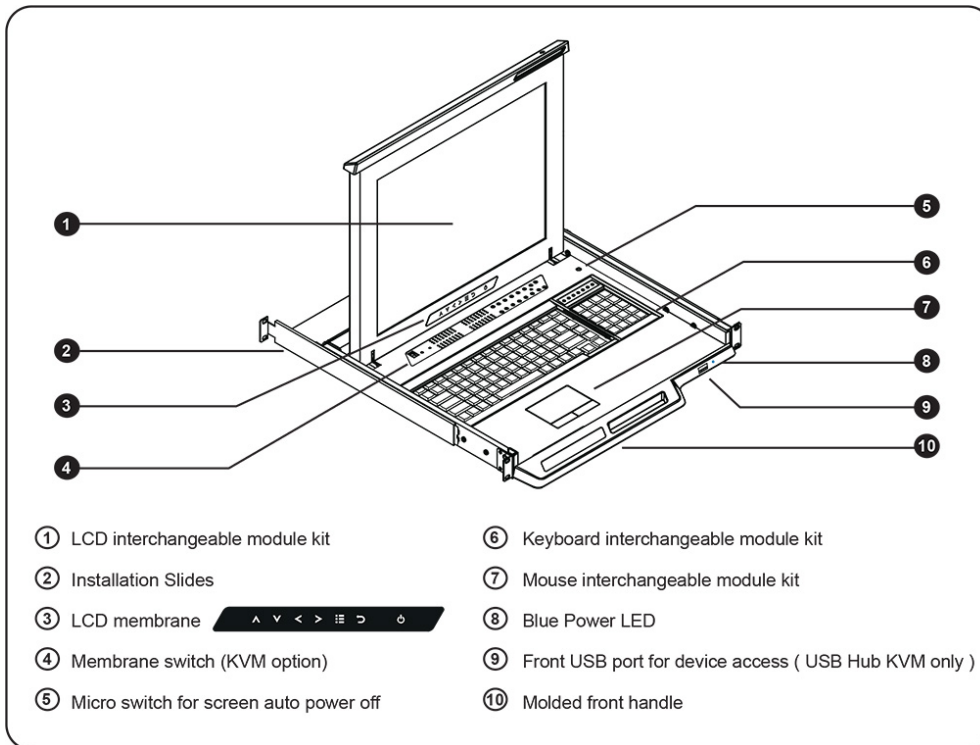

DIMENSION

This is subject to change without Notice. Final Drawings Will be Provided for Approval after Order.

Front View

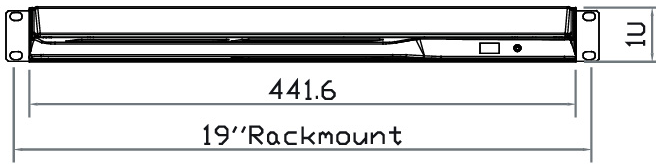

Rear View

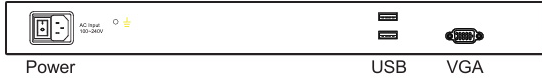

UNIT : mm
1mm = 0.03937 inch

Side View

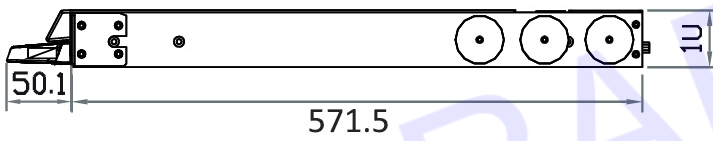

Top View

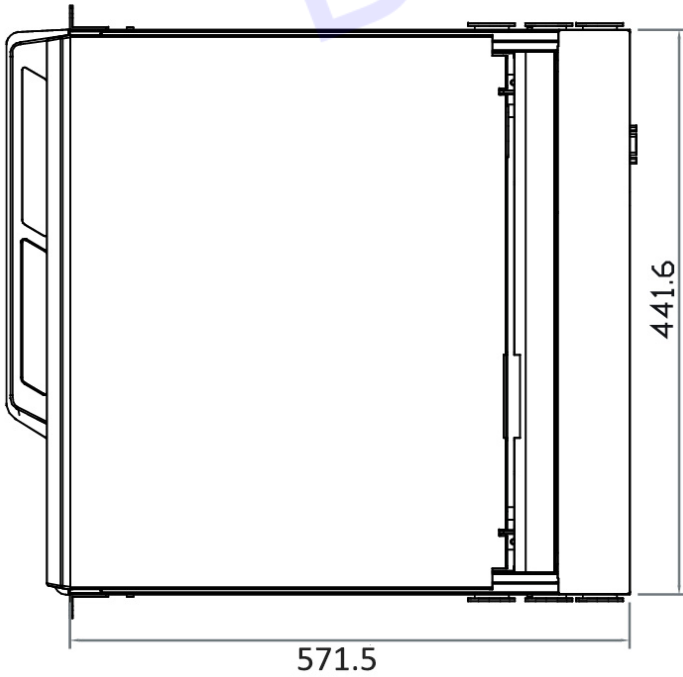

Drawing No.: NVP119e-TSR-USB-01302025-V1