

1U 17" LCD Keyboard KVM drawer, Combo Single Console  
 G keyboard w/ touch pad, DVI-D + HDMI w/ Speaker + Audio +  
 VGA & "Internal Power Adapter"

Include cable NB-6A (6ft Long VGA x 1 , USB x 1 Keyboard and USB 1 x Mouse)  
 Unit Depth : 20.9" (530mm)  
 Mounting distance : 18" ~ 32"

## MODEL: NVP117e-AU-IP



### BENEFITS:

- 17" LCD console drawer, occupying 1U of space.
- Native resolution of 1280 x 1024 with a vibrant palette of 16.7 million colors.
- Equipped with a 104-key keyboard, with touchpad.
- Designed for effortless installation by a single individual.
- Enhanced aesthetics featuring a sleek molded front handle.
- Comes with a standard 2-year warranty, with the option to extend it up to 5 years.

### SPECIFICATIONS

Console Port	
Video input	DVI-D+VGA+HDMI
KB / MS	USB interface
VGA console 6ft cable : NB-6A	Drawer end : DB-15 + USB type A x 2 Server end : DB-15 + USB type A x 2

LCD Panel	
Panel size ( diagonal )	17"
Native resolution	1280 x 1024
Brightness ( cd/m <sup>2</sup> )	250
Contrast ratio ( typ. )	1000 : 1
Colors	16.7 M
Viewing angle ( L/R/U/D )	85/85/80/80
Response time ( ms )	5
Dot pitch ( mm )	0.264
Display area ( mm )	337.92H x 270.33V
Surface treatment	Haze 25%, Hard-coating
Surface hardness	3H
Backlight type	LED
MTBF (hrs)	30,000

Video Option		
Digital	DVI	DVI-D single link
	HDMI	HDMI 1.4 / HDCP 1.4
Analog	S-Video ( 4-pin )	NTSC & PAL
	Composite ( BNC )	NTSC & PAL

Mounting Distance	
457 ~ 812 mm	
18 ~ 32 inch	

Audio Option		
Input	Connector	3.5mm stereo jack
	Impedance / Power level	30kΩ / 750mV
Output	Connector	3.5mm stereo jack
	Resistance / Power level	30kΩ / 2.8V
Speaker	Dual stereo	2W x 2

Power		
Input	Auto-sensing 100 to 240VAC, 50 / 60Hz	
Consumption (console / KVM)	Screen on	Max. 22W / Max. 55W
	Power saving mode	Max. 2W / Max. 34W
	Power button off	Max. 1W / Nil

Environment	
Operating temp.	-20 to 65°C degree
Storage temp.	-20 to 65°C degree
Operating humidity	20~90%, non-condensing
Storage humidity	5 ~90%, non-condensing
Operating altitude	16,000 ft
Non-operating altitude	40,000 ft
Shock	10G acceleration ( 11ms duration )
Vibration	10~300Hz 0.5G RMS random vibration

Compliance	
EMC	FCC, CE certified
Safety	CE / LVD, UKCA & CCC
Environment	RoHS3 & REACH / WEEE

*\*Specifications subject to change without notice, not responsible for typographical errors.*

## STANDARD KEYBOARD



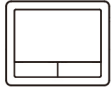





**Ge** G keyboard with touchpad



**Gb** G keyboard with trackball



### Supporting layouts

America						
	U.S.					
EMEA						
	U.K.	Germany	France	Russia	Spain	Italy
Asia						
	Japan	Korea				

## KEYBOARD OPTIONS

\* US layout only

**Se** S keyboard with touchpad



**Sb** S keyboard with trackball

## STRUCTURE DIAGRAM

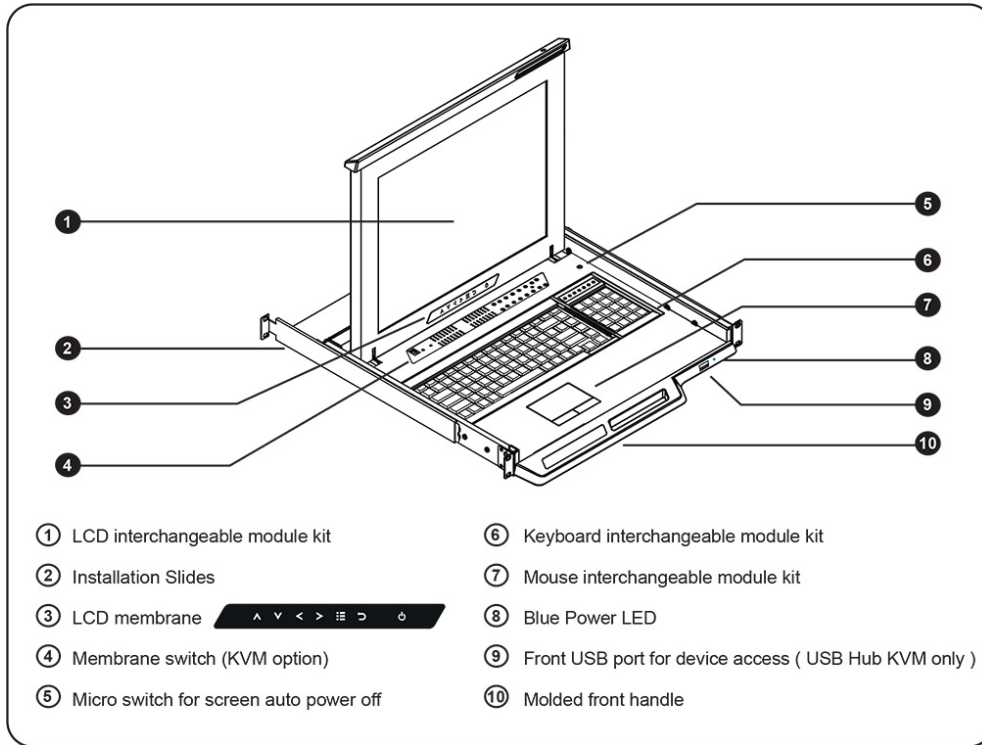

# DIMENSION

This is subject to change without Notice. Final Drawings Will be Provided for Approval after Order.

Left-side View

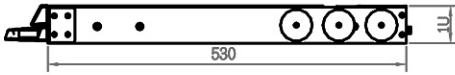

Front View

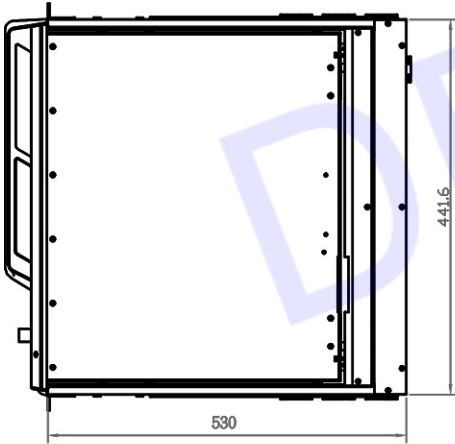
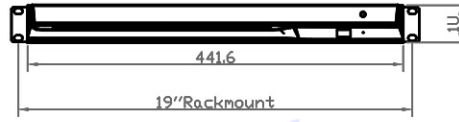

Top View

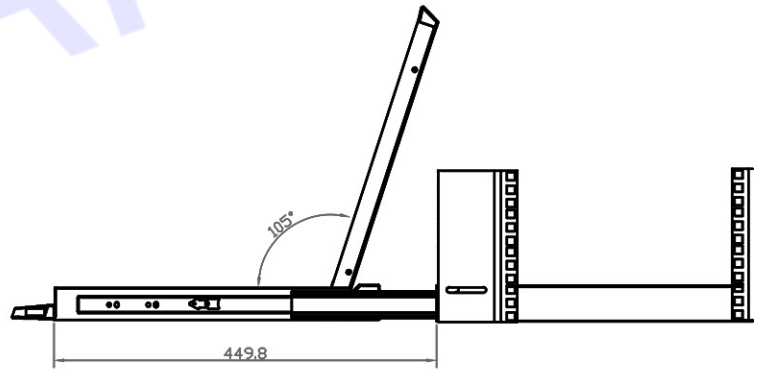

Drawing No.: NVP117e-AU-IP-03252024-V1