

1U Rackmount 17" TFT LCD Monitor w/ Notebook Keyboard & 3-Button Mini-trackball Drawer. (17.25"W x 18.1"D x 1.75"H), 1280x1024 Resolution with NB-6A (VGA+ 2xUSB KVM combo Cable 6ft long)

MODEL: NVP117b



BENEFITS:

- 1U 17" LCD console drawer
- 1280 x 1024 native resolution / 16.7M colors
- 104-key keyboard with either touchpad or trackball
- Short depth design of 460mm and 500mm respectively
- One Man installation design
- New enhanced aesthetics with molded front handle
- 2-year standard warranty (upgradable up to 5 years)

OPTIONS:

- HDMI 1.4 + DVI-D + Audio in & out + Speakers (AV4.4)
- HDMI 1.4 + Speakers (HDMI)
- S-Video + Composite + Speakers (BNC)
- 3G / HD / SD-SDI Broadcast-grade input + Speakers (SDI)
- Front USB hub port for device access (USB)
- 2-post rack mounting brackets (ORB-2.1)
- DC power : 12V / 24V / 48V / 125V / 250V
- SUN Micro keyboard option
- 17" Touchscreen : Projected Capacitive 10-pt / Resistive 1-pt

SPECIFICATIONS

Console Port	
Video input	VGA
KB / MS	USB interface
VGA console 6ft cable : NB-6A	Drawer end : DB-15 + USB type A x 2 Server end : DB-15 + USB type A x 2

LCD Panel	
Panel size (diagonal)	17"
Native resolution	1280 x 1024
Brightness (cd/m ²)	250
Contrast ratio (typ.)	1000 : 1
Colors	16.7 M
Viewing angle (L/R/U/D)	85/85/80/80
Response time (ms)	5
Dot pitch (mm)	0.264
Display area (mm)	337.92H x 270.33V
Surface treatment	Haze 25%, Hard-coating
Surface hardness	3H
Backlight type	LED
MTBF (hrs)	30,000

Physical		
Product (W x D x H)	Single console	442 x 460 x 44 mm 17.4 x 18.1 x 1.73 inch
	Console w/ KVM	442 x 580 x 44mm 17.4 x 22.8 x 1.73 inch
Packing (W x D x H)	Single console / Console w/ KVM	590 x 815 x 140 mm 23.2 x 32.1 x 5.5 inch
	Net weight	Single console
Console w/ KVM		13 kg / 28.6 lb
Gross weight	Single console	16.6 kg / 36.5 lb
	Console w/ KVM	19 kg / 41.8 lb

Mounting Distance	
Single console drawer	470 ~ 700 mm
Console w/ KVM drawer	18.5 ~ 27.6 inch
Console w/ KVM drawer	470 ~ 800 mm
	18.5 ~ 31.5 inch

Video Option		
Digital	DVI	DVI-D single link
	HDMI	HDMI 1.4 / HDCP 1.4
Analog	S-Video (4-pin)	NTSC & PAL
	Composite (BNC)	NTSC & PAL

HDMI

NVP117 chassis extension in depth to 480mm (18.9")

S-Video & Composite

NVP117 chassis extension in depth to 530mm (20.9")

Audio Option		
Input	Connector	3.5mm stereo jack
	Impedance / Power level	30kΩ / 750mV
Output	Connector	3.5mm stereo jack
	Resistance / Power level	30kΩ / 2.8V
Speaker	Dual stereo	2W x 2

Power		
Input	Auto-sensing 100 to 240VAC, 50 / 60Hz	
Consumption (console / KVM)	Screen on	Max. 22W / Max. 55W
	Power saving mode	Max. 2W / Max. 34W
	Power button off	Max. 1W / Nil

Environment	
Operating temp.	-20 to 65°C degree
Storage temp.	-20 to 65°C degree
Operating humidity	10~90%, non-condensing
Storage humidity	5 ~90%, non-condensing
Operating altitude	16,000 ft
Non-operating altitude	40,000 ft
Shock	10G acceleration (11ms duration)
Vibration	10~300Hz 0.5G RMS random vibration

Compliance	
EMC	FCC, CE certified
Safety	CE / LVD, UKCA & CCC
Environment	RoHS3 & REACH / WEEE

MODELS with KVM

2K KVM	IP	Remote	8-port	
	0	0	NVP117-D8	

2K KVM Cable



NK6D (6 ft)
DVI-D KVM cable



NK6H (6 ft)
HDMI KVM cable

Resolution Support **: 16:9 - max. 2560 x 1440
16:10 - max. 1920 x 1200
4:3 - max. 1600 x 1200

DVI-D KVM	IP	Remote	12-port	
	0	0	NVP117-D12	

DVI-D USB KVM Cable

Resolution Support **: 16:10 - max. 1920 x 1200
16:9 - max. 1920 x 1080
4:3 - max. 1600 x 1200



NI - 6 (6 ft)
NI - 15 (15 ft)

Matrix CAT6 KVM	IP	Remote	8-port	16-port	32-port
	1	1	-	NVP117-MC1116	NVP117-MC1132
	2	1	-	NVP117-MC2116	NVP117-MC3224
	0	1	-	NVP117-MC0116	NVP117-MC0132
	0	2	-	NVP117-MC0216	NVP117-MC0232
	0	3	-	NVP117-MC0316	NVP117-MC0332

CAT6 KVM Dongle



USB-C dongle



IF-DUSBP
DP - USB dongle



IF-DUSBH
HDMI - USB dongle



IF-DUSBD
DVI - USB dongle



IF-DUSB
VGA - USB dongle

Resolution Support **: 16:10 - max. 1920 x 1200
16:9 - max. 1920 x 1080
4:3 - max. 1600 x 1200

CAT6 Combo KVM	IP	Remote	8-port	16-port	32-port
	1	0	NVP117-CIP8	NVP117-CIP16	NVP117-CIP32
	0	1	NVP117-CCE8	NVP117-CCE16	NVP117-CCE32
0	0	NVP117-C8	NVP117-C16	NVP117-C32	

Matrix DB-15 KVM	IP	Remote	8-port	16-port
	1	1	NVP117-M118	NVP117-M1116
	2	1	NVP117-M218	NVP117-M2116
	0	1	NVP117-M018	NVP117-M0116
	0	2	NVP117-M028	NVP117-M0216
	0	3	NVP117-M038	NVP117-M0316

DB-15 VGA USB KVM Cable



NB - 6 (6 ft)



NB - 10 (10 ft)





NB - 15 (15 ft)

Resolution Support **: 16:10 - max. 1920 x 1200
16:9 - max. 1920 x 1080
4:3 - max. 1600 x 1200

Combo DB-15 KVM	IP	Remote	8-port	16-port
	1	0	NVP117-IP8	NVP117-IP16
	0	1	NVP117-CE8	NVP117-CE8
0	0	NVP117-S8	NVP117-S16	

IP Console







High Performance KVM Access Over IP

Connector : RJ45
 User management: 1 x active user, 15-user login
 Network protocol: DHCP / BOOTP / DNS
 Security : TLS 1.3, AES, LDAP, Active Directory (AD), HTTP(s)
 Browser : Chrome, Firefox, Edge, etc.
 Resolution : 16:9 - max. 1920x1080 / 16:10 - max. 1920x1200 / 4:3 - max. 1600x1200

STANDARD KEYBOARD



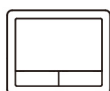
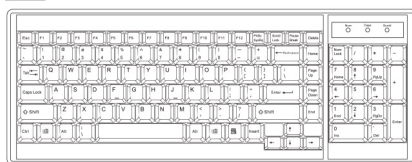





Ge G keyboard with touchpad



Gb G keyboard with trackball



Supporting layouts

America						
	U.S.					
EMEA						
	U.K.	Germany	France	Russia	Spain	Italy
Asia						
	Japan	Korea				

KEYBOARD OPTIONS *US Layout only

Se S keyboard with touchpad

Sb S keyboard with trackball



STRUCTURE DIAGRAM

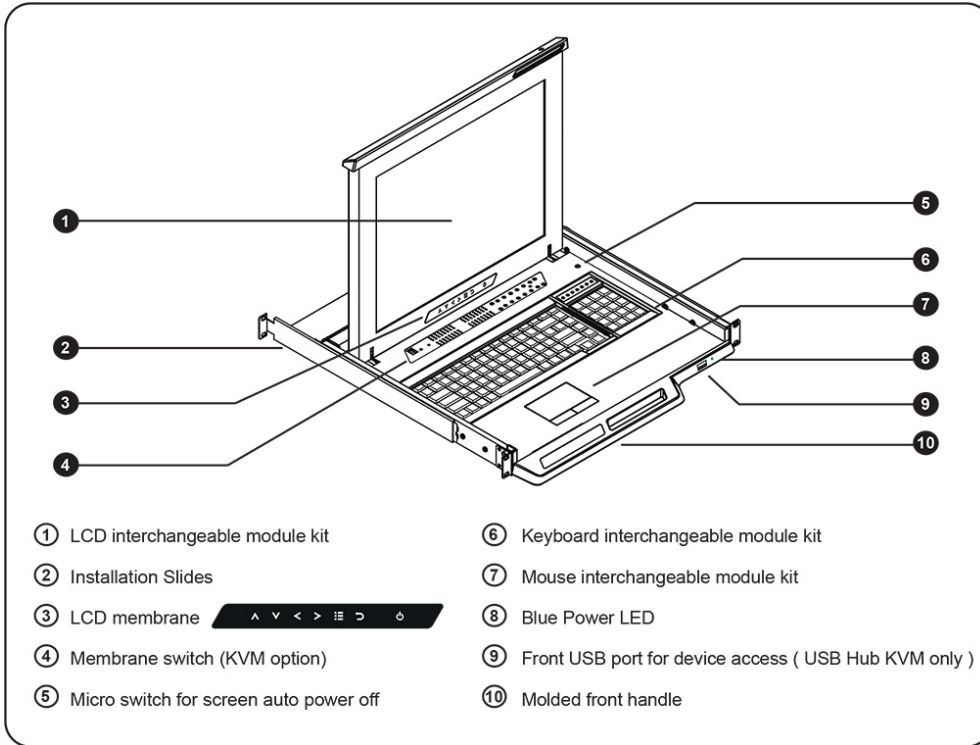

DIMENSION

This is subject to change without Notice. Final Drawings Will be Provided for Approval after Order.

Front View

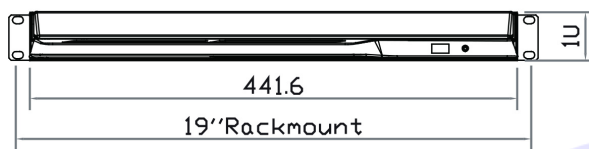

Rear View



Side View

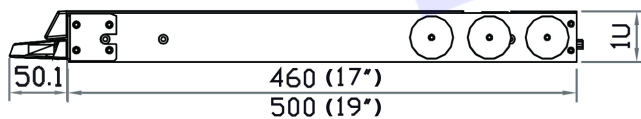

Top View

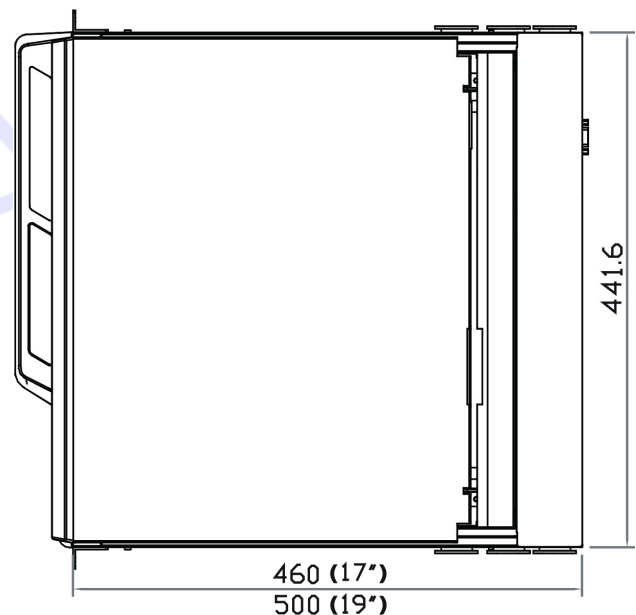

Drawing No.: NVP117b-05052022-V1