

17" 1280x1024 1U LCD Console Drawer Short Depth Design with VGA + SDI Video Input, 104-Key Keyboard Trackball (b)

MODEL: NVP117b-SDI



BENEFITS:

- 1U 17" LCD console drawer
- 1280 x 1024 native resolution / 16.7M colors
- 104-key keyboard with either touchpad or trackball
- Short depth design of 460mm and 500mm respectively
- One Man installation design
- New enhanced aesthetics with molded front handle
- 2-year standard warranty (upgradable up to 5 years)

OPTIONS:

- Front USB hub port for device access
- HDMI 1.4 + DVI-D + Audio input & output
- HDMI 1.4 + DVI-D video input
- 3G / HD / SD-SDI Broadcast-grade input
- S-Video + Composite
- 2-post rack mounting brackets
- DC power : 12V / 24V / 48V / 125V
- MAC or SUN Micro keyboard options available
- 17" Touchscreen : Projected Capacitive 10-pt / Capacitive 1-pt / Resistive 1-pt

SPECIFICATIONS

| Console Port | |
|-------------------------------|--|
| Video input | VGA + SDI |
| KB / MS | USB interface |
| VGA console 6ft cable : NB-6A | Drawer end : DB-15 + USB type A x 2 Server end : DB-15 + USB type A x 2 |

| LCD Panel | |
|----------------------------------|------------------------|
| Panel size (diagonal) | 17" |
| Native resolution | 1280 x 1024 |
| Brightness (cd/m ²) | 250 |
| Contrast ratio (typ.) | 1000 : 1 |
| Colors | 16.7 M |
| Viewing angle (L/R/U/D) | 85/85/80/80 |
| Response time (ms) | 5 |
| Dot pitch (mm) | 0.264 |
| Display area (mm) | 337.92H x 270.33V |
| Surface treatment | Haze 25%, Hard-coating |
| Surface hardness | 3H |
| Backlight type | LED |
| MTBF (hrs) | 30,000 |

| Physical | | |
|-----------------------|---------------------------------|--|
| Product (W x D x H) | Single console | 442 x 460 x 44 mm 17.4 x 18.1 x 1.73 inch |
| | Console w/ KVM | 442 x 580 x 44mm 17.4 x 22.8 x 1.73 inch |
| Packing (W x D x H) | Single console / Console w/ KVM | 590 x 815 x 140 mm 23.2 x 32.1 x 5.5 inch |
| | Net weight | Single console |
| Console w/ KVM | | 13 kg / 28.6 lb |
| Gross weight | Single console | 16.6 kg / 36.5 lb |
| | Console w/ KVM | 19 kg / 41.8 lb |

| Mounting Distance | |
|-----------------------|------------------|
| Single console drawer | 470 ~ 700 mm |
| Console w/ KVM drawer | 18.5 ~ 27.6 inch |
| Console w/ KVM drawer | 470 ~ 800 mm |
| | 18.5 ~ 31.5 inch |

| Video Option | | |
|--------------|-------------------|---------------------|
| Digital | DVI | DVI-D single link |
| | HDMI | HDMI 1.4 / HDCP 1.4 |
| Analog | S-Video (4-pin) | NTSC & PAL |
| | Composite (BNC) | NTSC & PAL |

HDMI

NVP117 chassis extension in depth to 480mm (18.9")

S-Video & Composite

NVP117 chassis extension in depth to 530mm (20.9")

| Audio Option | | |
|--------------|--------------------------|-------------------|
| Input | Connector | 3.5mm stereo jack |
| | Impedance / Power level | 30kQ / 750mV |
| Output | Connector | 3.5mm stereo jack |
| | Resistance / Power level | 30kQ / 2.8V |
| Speaker | Dual stereo | 2W x 2 |

| Power | | |
|-----------------------------|---------------------------------------|---------------------|
| Input | Auto-sensing 100 to 240VAC, 50 / 60Hz | |
| Consumption (console / KVM) | Screen on | Max. 22W / Max. 55W |
| | Power saving mode | Max. 2W / Max. 34W |
| | Power button off | Max. 1W / Nil |

| Environment | |
|------------------------|------------------------------------|
| Operating temp. | -20 to 65°C degree |
| Storage temp. | -20 to 60°C degree |
| Operating humidity | 20~90%, non-condensing |
| Storage humidity | 5 ~90%, non-condensing |
| Operating altitude | 16,000 ft |
| Non-operating altitude | 40,000 ft |
| Shock | 10G acceleration (11ms duration) |
| Vibration | 10~300Hz 0.5G RMS random vibration |

| Compliance | |
|-------------|----------------------|
| EMC | FCC, CE certified |
| Safety | CE / LVD, UKCA & CCC |
| Environment | RoHS3 & REACH |

MODELS with KVM

| | | | | |
|--------|-----------|--------|-----------|--|
| 2K KVM | IP | Remote | 8-port | |
| | 0 | 0 | NVP117-D8 | |

2K KVM Cable



NK6D (6 ft)
DVI-D KVM cable



NK6H (6 ft)
HDMI KVM cable

Resolution Support **: 16:9 - max. 2560 x 1440
16:10 - max. 1920 x 1200
4:3 - max. 1600 x 1200

| | | | | |
|-----------|-----------|--------|------------|--|
| DVI-D KVM | IP | Remote | 12-port | |
| | 0 | 0 | NVP117-D12 | |

DVI-D USB KVM Cable

Resolution Support **: 16:10 - max. 1920 x 1200
16:9 - max. 1920 x 1080
4:3 - max. 1600 x 1200



NI - 6 (6 ft)
NI - 15 (15 ft)

| | | | | | |
|--------------------|-----------|--------|--------|---------------|---------------|
| Matrix CAT6 KVM | IP | Remote | 8-port | 16-port | 32-port |
| | 1 | 1 | - | NVP117-MC1116 | NVP117-MC1132 |
| | 2 | 1 | - | NVP117-MC2116 | NVP117-MC3224 |
| | 0 | 1 | - | NVP117-MC0116 | NVP117-MC0132 |
| | 0 | 2 | - | NVP117-MC0216 | NVP117-MC0232 |
| | 0 | 3 | - | NVP117-MC0316 | NVP117-MC0332 |

CAT6 KVM Dongle



USB-C dongle



IF-DUSBP
DP - USB dongle



IF-DUSBH
HDMI - USB dongle



IF-DUSBD
DVI - USB dongle



IF-DUSB
VGA - USB dongle

Resolution Support **: 16:10 - max. 1920 x 1200
16:9 - max. 1920 x 1080
4:3 - max. 1600 x 1200

| | | | | | |
|----------------------|-----------|-----------|-------------|--------------|--------------|
| CAT6 Combo KVM | IP | Remote | 8-port | 16-port | 32-port |
| | 1 | 0 | NVP117-CIP8 | NVP117-CIP16 | NVP117-CIP32 |
| | 0 | 1 | NVP117-CCE8 | NVP117-CCE16 | NVP117-CCE32 |
| 0 | 0 | NVP117-C8 | NVP117-C16 | NVP117-C32 | |

| | | | | |
|---------------------|-----------|--------|-------------|--------------|
| Matrix DB-15 KVM | IP | Remote | 8-port | 16-port |
| | 1 | 1 | NVP117-M118 | NVP117-M1116 |
| | 2 | 1 | NVP117-M218 | NVP117-M2116 |
| | 0 | 1 | NVP117-M018 | NVP117-M0116 |
| | 0 | 2 | NVP117-M028 | NVP117-M0216 |
| | 0 | 3 | NVP117-M038 | NVP117-M0316 |

DB-15 VGA USB KVM Cable



NB - 6 (6 ft)



NB - 10 (10 ft)





NB - 15 (15 ft)

Resolution Support **: 16:10 - max. 1920 x 1200
16:9 - max. 1920 x 1080
4:3 - max. 1600 x 1200

| | | | | |
|--------------------|-----------|-----------|------------|-------------|
| Combo DB-15 KVM | IP | Remote | 8-port | 16-port |
| | 1 | 0 | NVP117-IP8 | NVP117-IP16 |
| | 0 | 1 | NVP117-CE8 | NVP117-CE8 |
| 0 | 0 | NVP117-S8 | NVP117-S16 | |

IP Console







High Performance KVM Access Over IP

Connector : RJ45
 User management: 1 x active user, 15-user login
 Network protocol: DHCP / BOOTP / DNS
 Security : TLS 1.3, AES, LDAP, Active Directory (AD), HTTP(s)
 Browser : Chrome, Firefox, Edge, etc.
 Resolution : 16:9 - max. 1920x1080 / 16:10 - max. 1920x1200 / 4:3 - max. 1600x1200

STANDARD KEYBOARD



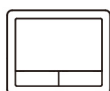
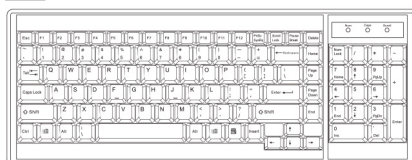



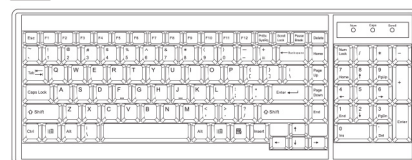

Ge G keyboard with touchpad



Gb G keyboard with trackball



Supporting layouts

| | | | | | | |
|---------|---|---|---|---|---|---|
| America |  | | | | | |
| | U.S. | | | | | |
| EMEA |  |  |  |  |  |  |
| | U.K. | Germany | France | Russia | Spain | Italy |
| Asia |  |  | | | | |
| | Japan | Korea | | | | |

KEYBOARD OPTIONS

* US layout only

Me Mac keyboard with touchpad



Se S keyboard with touchpad

Mb Mac keyboard with trackball

Sb S keyboard with trackball



STRUCTURE DIAGRAM

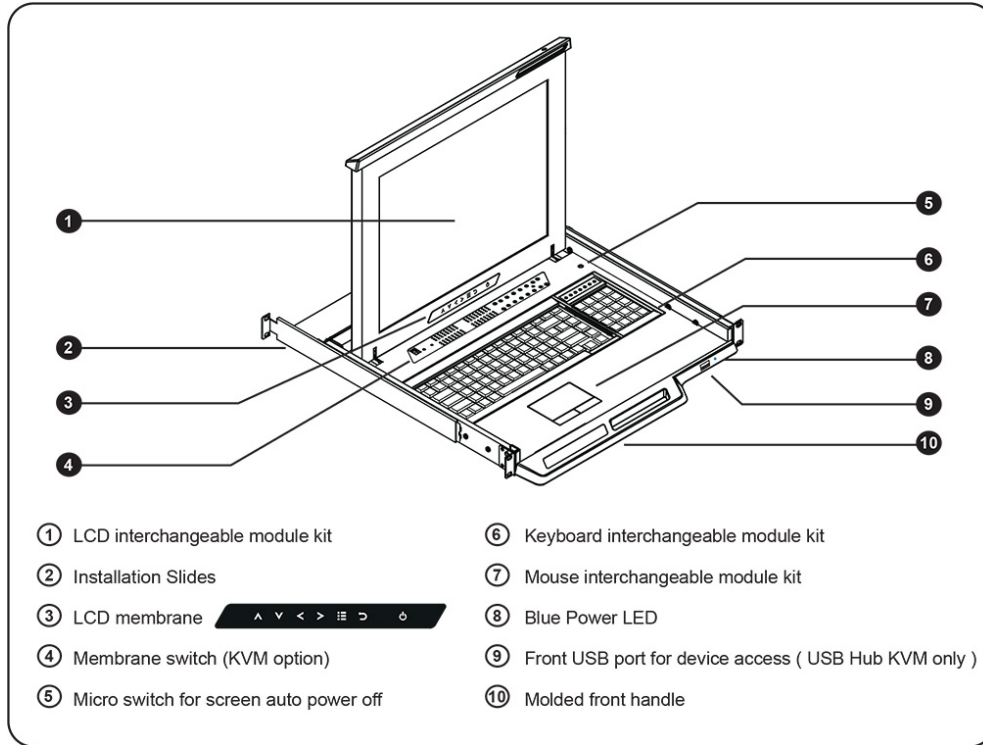

DIMENSION

This is subject to change without Notice. Final Drawings Will be Provided for Approval after Order.

Front View

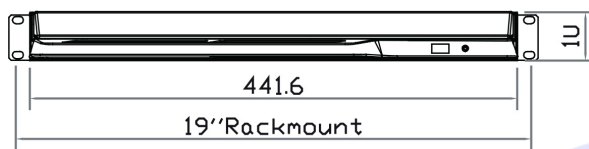

Rear View



Side View

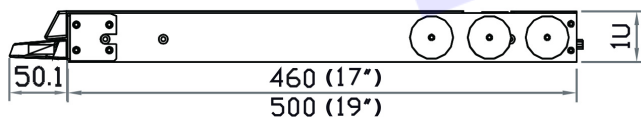

Top View

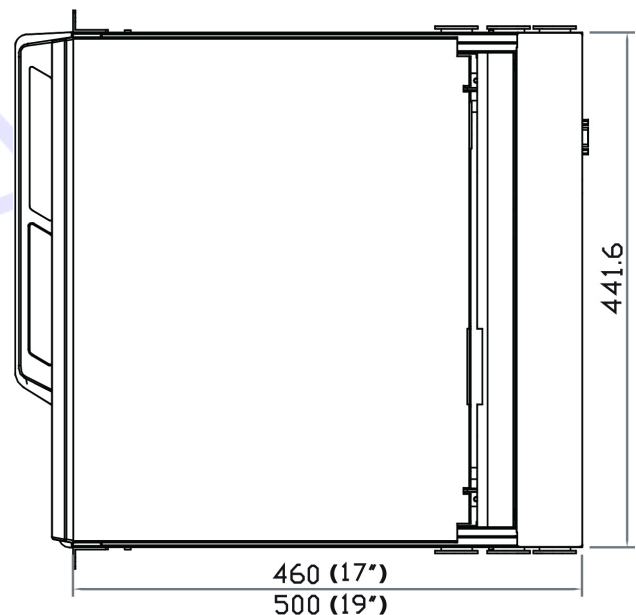

Drawing No.: NVP117b-SDI-05052022-V1