

17" 1280x1024 1U LCD Console Drawer Short Depth Design with VGA + DVI-D + HDMI Video Input, 104-Key Keyboard Trackball (b)

**MODEL: NVP117b-HDMI**



### BENEFITS:

- 1U 17" LCD console drawer
- 1280 x 1024 native resolution / 16.7M colors
- 104-key keyboard with either touchpad or trackball
- Short depth design of 460mm and 500mm respectively
- One Man installation design
- New enhanced aesthetics with molded front handle
- 2-year standard warranty (upgradable up to 5 years)

### OPTIONS:

- Front USB hub port for device access
- HDMI 1.4 + DVI-D + Audio input & output
- HDMI 1.4 + DVI-D video input
- 3G / HD / SD-SDI Broadcast-grade input
- S-Video + Composite ( BNC )
- 2-post rack mounting brackets
- DC power : 12V / 24V / 48V / 125V
- MAC or SUN Micro keyboard options available
- 17" Touchscreen : Projected Capacitive 10-pt / Capacitive 1-pt / Resistive 1-pt

### SPECIFICATIONS

Console Port	
Video input	VGA + DVI-D + HDMI
KB / MS	USB interface
VGA console 6ft cable : NB-6A	Drawer end : DB-15 + USB type A x 2 Server end : DB-15 + USB type A x 2

LCD Panel	
Panel size ( diagonal )	17"
Native resolution	1280 x 1024
Brightness ( cd/m <sup>2</sup> )	250
Contrast ratio ( typ. )	1000 : 1
Colors	16.7 M
Viewing angle ( L/R/U/D )	85/85/80/80
Response time ( ms )	5
Dot pitch ( mm )	0.264
Display area ( mm )	337.92H x 270.33V
Surface treatment	Haze 25%, Hard-coating
Surface hardness	3H
Backlight type	LED
MTBF (hrs)	30,000

Physical		
Product ( WxDxH )	Single console	442 x 460 x 44 mm 17.4 x 18.1 x 1.73 inch
	Console w/ KVM	442 x 580 x 44mm 17.4 x 22.8 x 1.73 inch
Packing ( WxDxH )	Single console / Console w/ KVM	590 x 815 x 140 mm 23.2 x 32.1 x 5.5 inch
	Net weight	Single console
Console w/ KVM		13 kg / 28.6 lb
Gross weight	Single console	16.6 kg / 36.5 lb
	Console w/ KVM	19 kg / 41.8 lb

Mounting Distance	
Single console drawer	470 ~ 700 mm
Console w/ KVM drawer	18.5 ~ 27.6 inch
Console w/ KVM drawer	470 ~ 800 mm
	18.5 ~ 31.5 inch

Video Option		
Digital	DVI	DVI-D single link
	HDMI	HDMI 1.4 / HDCP 1.4
Analog	S-Video ( 4-pin )	NTSC & PAL
	Composite ( BNC )	NTSC & PAL

#### HDMI

NVP117 chassis extension in depth to 480mm ( 18.9" )

#### S-Video & Composite

NVP117 chassis extension in depth to 530mm ( 20.9" )

Audio Option		
Input	Connector	3.5mm stereo jack
	Impedance / Power level	30kQ / 750mV
Output	Connector	3.5mm stereo jack
	Resistance / Power level	30kQ / 2.8V
Speaker	Dual stereo	2W x 2

Power		
Input	Auto-sensing 100 to 240VAC, 50 / 60Hz	
Consumption (console / KVM)	Screen on	Max. 22W / Max. 55W
	Power saving mode	Max. 2W / Max. 34W
	Power button off	Max. 1W / Nil

Environment	
Operating temp.	-20 to 65°C degree
Storage temp.	-20 to 60°C degree
Operating humidity	20~90%, non-condensing
Storage humidity	5 ~90%, non-condensing
Operating altitude	16,000 ft
Non-operating altitude	40,000 ft
Shock	10G acceleration ( 11ms duration )
Vibration	10~300Hz 0.5G RMS random vibration

Compliance	
EMC	FCC, CE certified
Safety	CE / LVD, UKCA & CCC
Environment	RoHS3 & REACH

## MODELS with KVM

2K KVM	<b>IP</b>	Remote	8-port	
	0	0	NVP117-D8	

### 2K KVM Cable



NK6D (6 ft)  
DVI-D KVM cable



NK6H (6 ft)  
HDMI KVM cable

Resolution Support \*\*: 16:9 - max. 2560 x 1440  
16:10 - max. 1920 x 1200  
4:3 - max. 1600 x 1200

DVI-D KVM	<b>IP</b>	Remote	12-port	
	0	0	NVP117-D12	

### DVI-D USB KVM Cable

Resolution Support \*\*: 16:10 - max. 1920 x 1200  
16:9 - max. 1920 x 1080  
4:3 - max. 1600 x 1200



NI - 6 (6 ft)  
NI - 15 (15 ft)

Matrix CAT6 KVM	<b>IP</b>	Remote	8-port	16-port	32-port
	1	1	-	NVP117-MC1116	NVP117-MC1132
	2	1	-	NVP117-MC2116	NVP117-MC3224
	0	1	-	NVP117-MC0116	NVP117-MC0132
	0	2	-	NVP117-MC0216	NVP117-MC0232
	0	3	-	NVP117-MC0316	NVP117-MC0332

### CAT6 KVM Dongle



USB-C dongle



IF-DUSBP  
DP - USB dongle



IF-DUSBH  
HDMI - USB dongle



IF-DUSBD  
DVI - USB dongle



IF-DUSB  
VGA - USB dongle

Resolution Support \*\*: 16:10 - max. 1920 x 1200  
16:9 - max. 1920 x 1080  
4:3 - max. 1600 x 1200

CAT6 Combo KVM	<b>IP</b>	Remote	8-port	16-port	32-port
	1	0	NVP117-CIP8	NVP117-CIP16	NVP117-CIP32
	0	1	NVP117-CCE8	NVP117-CCE16	NVP117-CCE32
0	0	NVP117-C8	NVP117-C16	NVP117-C32	

Matrix DB-15 KVM	<b>IP</b>	Remote	8-port	16-port
	1	1	NVP117-M118	NVP117-M1116
	2	1	NVP117-M218	NVP117-M2116
	0	1	NVP117-M018	NVP117-M0116
	0	2	NVP117-M028	NVP117-M0216
	0	3	NVP117-M038	NVP117-M0316

### DB-15 VGA USB KVM Cable



NB - 6 (6 ft)



NB - 10 (10 ft)





NB - 15 (15 ft)

Resolution Support \*\*: 16:10 - max. 1920 x 1200  
16:9 - max. 1920 x 1080  
4:3 - max. 1600 x 1200

Combo DB-15 KVM	<b>IP</b>	Remote	8-port	16-port
	1	0	NVP117-IP8	NVP117-IP16
	0	1	NVP117-CE8	NVP117-CE8
0	0	NVP117-S8	NVP117-S16	

## IP Console







**High Performance KVM Access Over IP**

Connector : RJ45  
 User management: 1 x active user, 15-user login  
 Network protocol: DHCP / BOOTP / DNS  
 Security : TLS 1.3, AES, LDAP, Active Directory (AD), HTTP(s)  
 Browser : Chrome, Firefox, Edge, etc.  
 Resolution : 16:9 - max. 1920x1080 / 16:10 - max. 1920x1200 / 4:3 - max. 1600x1200

## STANDARD KEYBOARD



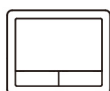
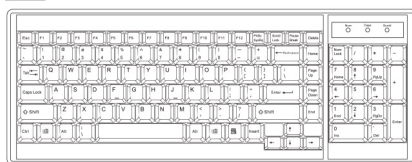





**Ge** G keyboard with touchpad



**Gb** G keyboard with trackball



### Supporting layouts

America						
	U.S.					
EMEA						
	U.K.	Germany	France	Russia	Spain	Italy
Asia						
	Japan	Korea				

## KEYBOARD OPTIONS

\* US layout only

**Me** Mac keyboard with touchpad



**Se** S keyboard with touchpad

**Mb** Mac keyboard with trackball

**Sb** S keyboard with trackball



## STRUCTURE DIAGRAM

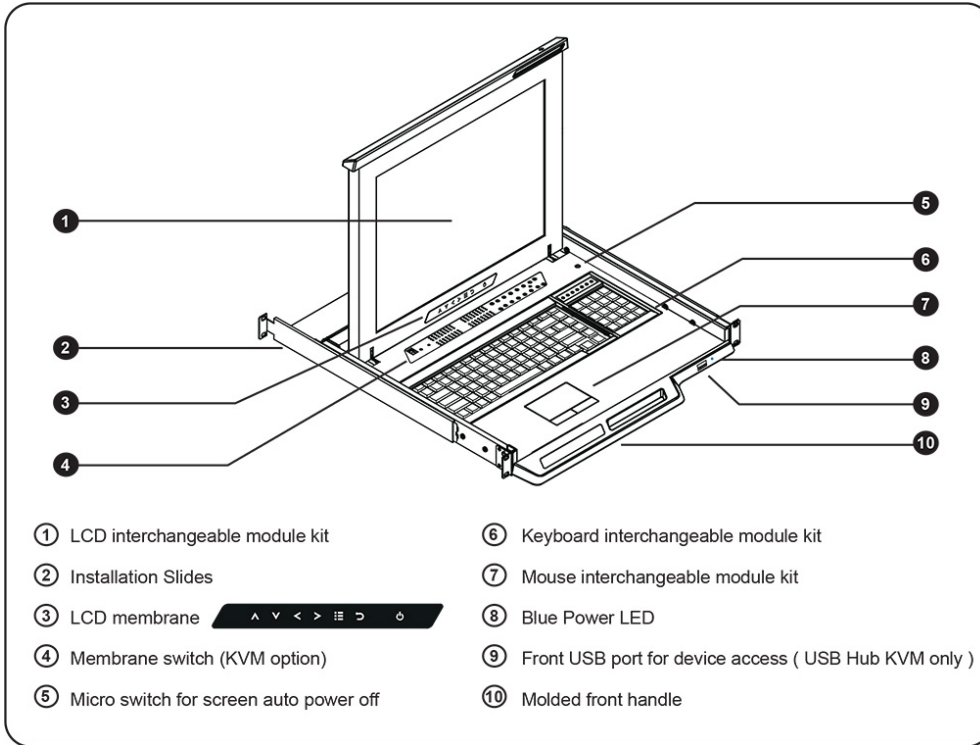

## DIMENSION

*This is subject to change without Notice. Final Drawings Will be Provided for Approval after Order.*

### Front View

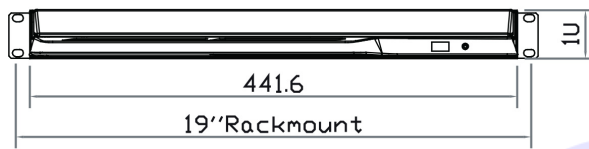

### Rear View

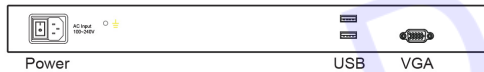

### Side View

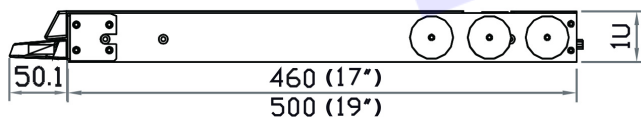

### Top View

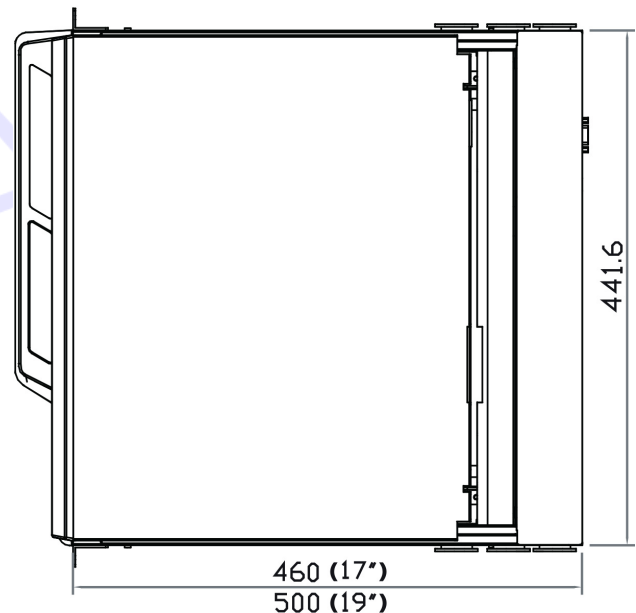

Drawing No.: NVP117b-HDMI-05052022-V1