

1U Rackmount 17" TFT LCD Monitor w/notebook keyboard with TouchPad  
 Drawer w/ 8-ports USB/PS2 Combo KVM (Includes 8pcs 6ft Long KVM  
 NE-6 Cables) + HDMI x 1 Video Input (Peer to Peer connection, for single  
 device only,)

**MODEL: NVP117-S801e-H**



**BENEFITS:**

- 1U 17" LCD console drawer
- 1280 x 1024 native resolution / 16.7M colors
- 104-key keyboard with either touchpad or trackball
- One Man installation design
- New enhanced aesthetics with molded front handle
- 2-year standard warranty ( upgradable up to 5 years )

**OPTIONS:**

- Front USB hub port for device access
- HDMI 1.4 + DVI-D + Audio input & output
- HDMI 1.4 + DVI-D video input
- 3G / HD / SD-SDI Broadcast-grade input
- S-Video + Composite
- 2-post rack mounting brackets
- DC power : 12V / 24V / 48V / 125V
- MAC or SUN Micro keyboard options available
- 17" Touchscreen : Projected Capacitive 10-pt / Capacitive 1-pt / Resistive 1-pt

**SPECIFICATIONS**

LCD Panel	
Panel size ( diagonal )	17"
Native resolution	1280 x 1024
Brightness ( cd/m <sup>2</sup> )	250
Contrast ratio ( typ. )	1000 : 1
Colors	16.7 M
Viewing angle ( L/R/U/D )	85/85/80/80
Response time ( ms )	5
Dot pitch ( mm )	0.264
Display area ( mm )	337.92H x 270.33V
Surface treatment	Haze 25%, Hard-coating
Surface hardness	3H
Backlight type	LED
MTBF (hrs)	30,000

Environment	
Operating temp.	-20 to 65°C degree
Storage temp.	-20 to 60°C degree
Operating humidity	20~90%, non-condensing
Storage humidity	5 ~90%, non-condensing
Operating altitude	16,000 ft
Non-operating altitude	40,000 ft
Shock	10G acceleration ( 11ms duration )
Vibration	10~300Hz 0.5G RMS random vibration

*\*Specifications subject to change without notice, not responsible for typographical errors.*

Power		
Input	Auto-sensing 100 to 240VAC, 50 / 60Hz	
Consumption (console / KVM)	Screen on	Max. 22W / Max. 55W
	Power saving mode	Max. 2W / Max. 34W
	Power button off	Max. 1W / Nil

Compliance	
EMC	FCC, CE certified
Safety	CE / LVD, UKCA & CCC
Environment	RoHS3 & REACH

## COMBO DB-15 KVM BENEFITS

- Combo DB-15 KVM with 8 ports in 1U
- Cascade switches up to 8 levels & Mix switches between Cat6 & Combo DB-15 KVM
- Mix PS/2, USB & SUN with Multi-Platform switch capability
- Support resolution up to 1920 x 1080
- SUN 1152 x 900 resolution compatible
- Hot pluggable, no software or drivers required
- Easy & quick installation

## SWITCH FEATURES & OPTIONS

- Multi lingual on screen display menu
- Advanced user profiles and configurable OSD hot key combinations
- 12V, 24V and 48V DC Power options

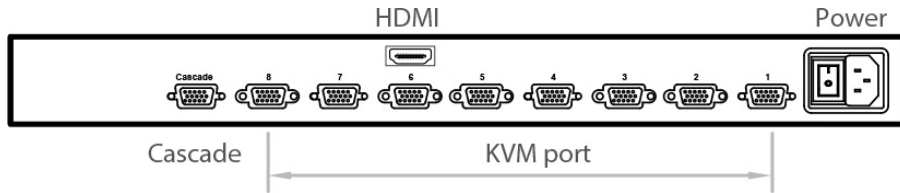

Console	Local	Remote	IP	Ports
	1	0		8

## COMBO DB-15 KVM BENEFITS

KVM Port	
Number of ports:	8
Connector:	DB-15 combo connector
Connectivity:	Combo 4-in-1 KVM cable, up to 6, 10 & 15 feet
Management	
Multilingual OSD:	English, France, German, Spanish, Italian, Russian, Simplified Chinese, Japanese
Hotkey combination:	Scroll-lock, Cap-lock, Num-lock, Alt, Ctrl & Win
Security:	Password enable & disable, up to 8 users profile for port access
PC Selection:	Front button, OSD menu & hotkey
Expansion:	Up to 128 servers by 8-level cascade
Compatibility	
Multi-platform:	Mix PCs, SUN and Mac G3 / G4 Mac / iMac
Support:	Windows 7 / Vista / 2003 / XP, Linux, Unix

<b>Regulatory :</b>	
Safety:	cUL, FCC & CE certified
Environment:	RoHS2 & REACH compliant
Environmental	
Operating:	0 to 50°C
Storage:	-5 to 60°C
Relative humidity:	90%, non-condensing
Shock:	50G peak acceleration (11ms, half-sine wave)
Vibration:	58-100Hz / 0.98G (11ms / cycle)

## STANDARD KEYBOARD

**Ge** G keyboard with touchpad

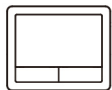
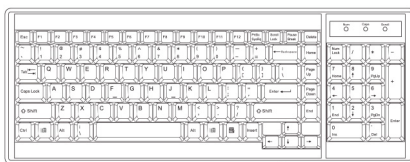

**Gb** G keyboard with trackball

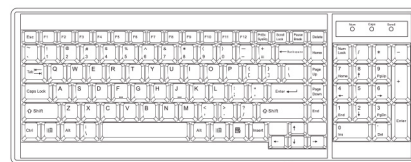

### Supporting layouts

America U.S.

EMEA U.K. Germany France Russia Spain Italy

Asia Japan Korea

## KEYBOARD OPTIONS

\* US layout only

**Me** Mac keyboard with touchpad



**Se** S keyboard with touchpad

**Mb** Mac keyboard with trackball

**Sb** S keyboard with trackball



## STRUCTURE DIAGRAM

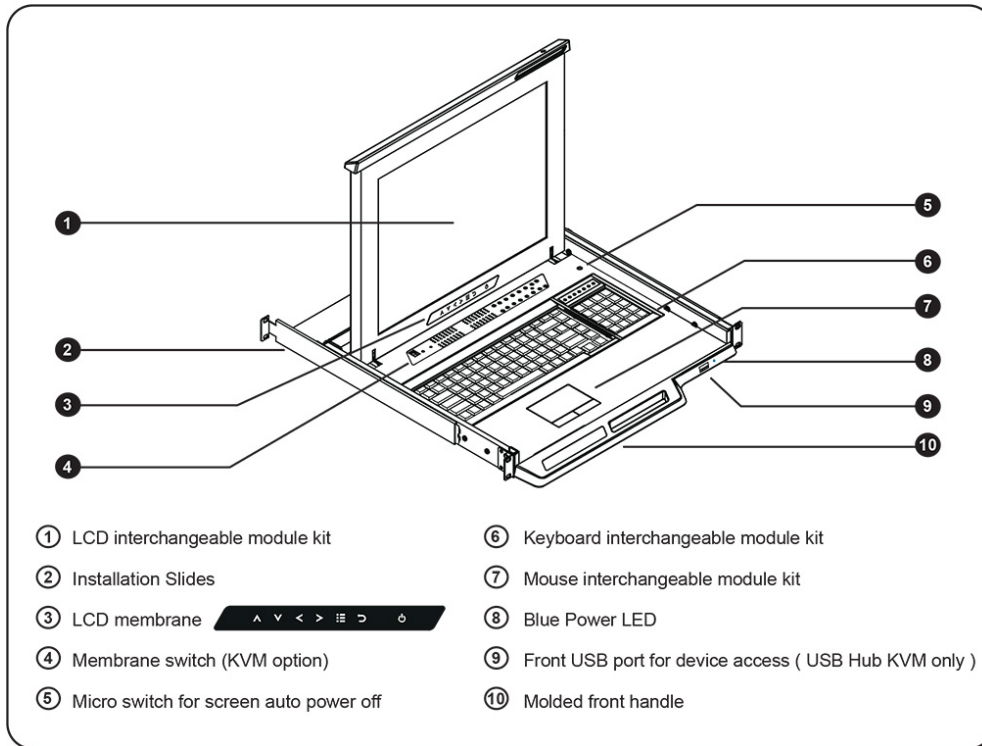

## KVM PORT CONNECTION

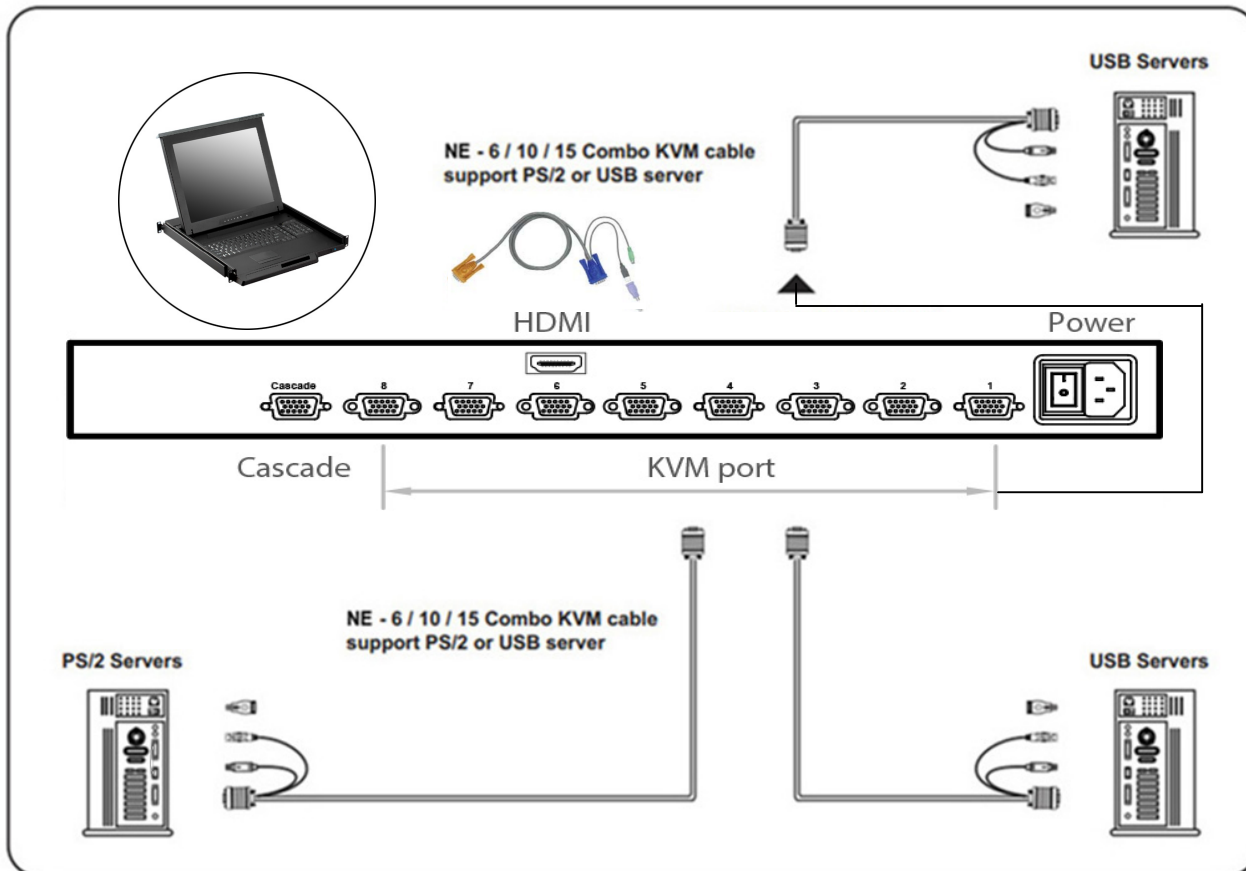

# DIMENSION

This is subject to change without Notice. Final Drawings Will be Provided for Approval after Order.

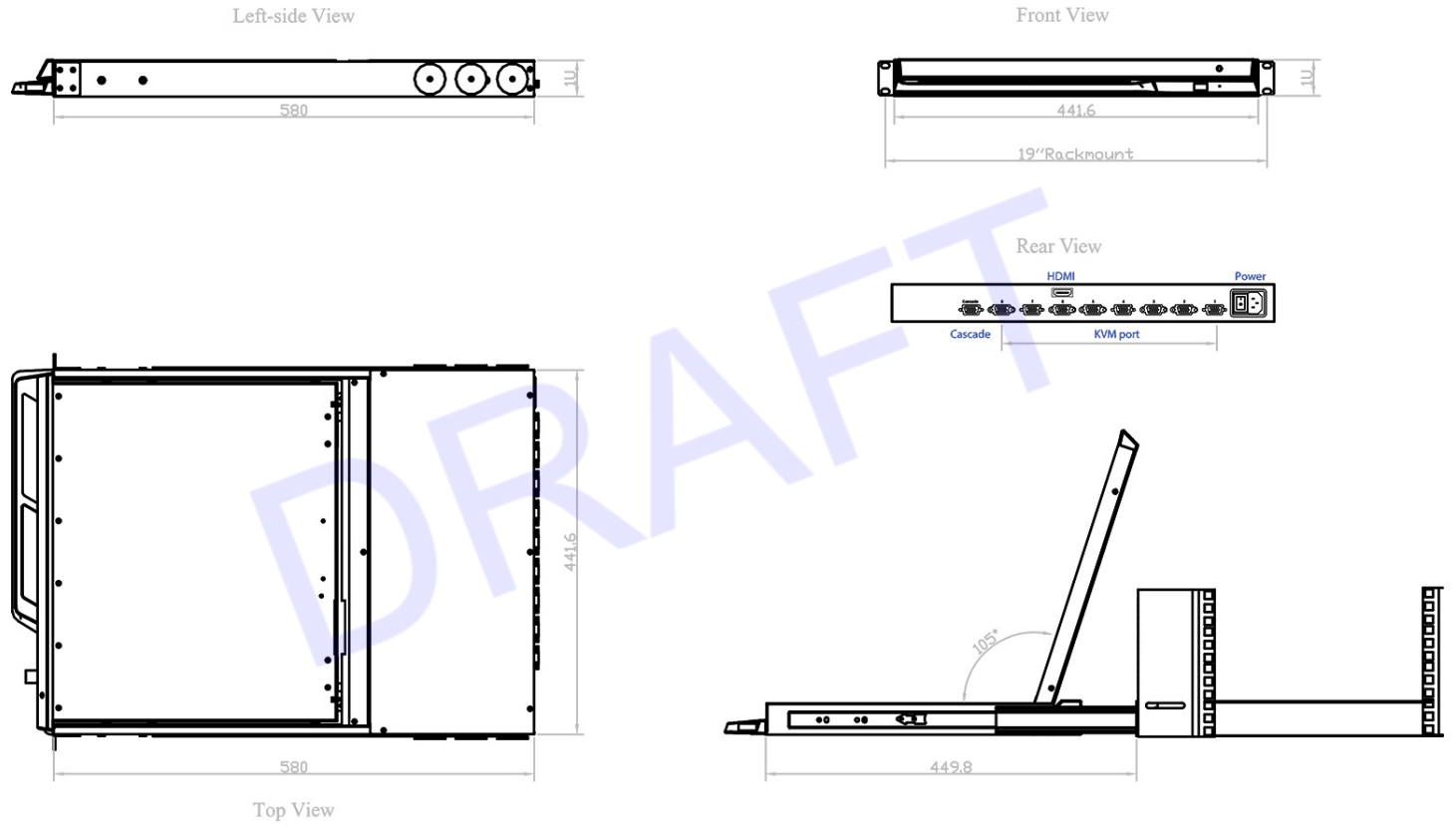

Unit : mm

Drawing No.: NVP117-S801e-H-09202022-V1