

1U 17" Sunlight Readable FHD LCD Console Drawer 1920x1080  
1000nits 8-Ports 2K HDMI USB KVM, 104 key keyboard w/  
touchpad.

Model: NPW117-8Ke



## BENEFITS:

- 1U 17" LCD console drawer
- Front USB hub port for device access
- 1920 x 1080 native resolution / 16.7M colors ( 8-bit ) / 1000 cd/m<sup>2</sup> brightness
- 104-key keyboard with either touchpad or trackball
- One Man installation design
- New enhanced aesthetics with molded front handle
- 2-year standard warranty ( upgradable up to 5 years )

## SPECIFICATIONS

LCD Panel	
Panel size ( diagonal )	17.3"
Native resolution	1920 x 1080
Brightness ( cd/m <sup>2</sup> )	1000
Contrast ratio ( typ. )	600 : 1
Colors	16.7 M, 8-bit
Viewing angle ( L/R/U/D )	80/80/60/80
Response time ( ms )	5.5
Dot pitch ( mm )	0.1989
Display area ( mm )	381.888H x 214.812V
Surface treatment	Anti-glare, Hard-coating
Surface hardness	3H
Backlight type	LED
MTBF ( hrs )	50,000

Physical		
Product ( W x D x H )	Console w/ KVM	442 x 580 x 44 mm 17.4 x 22.8 x 1.73 inch
Packing ( W x D x H )	Console w/ KVM	590 x 808 x 140 mm 23.2 x 31.8 x 5.5 inch
Net weight	Console w/ KVM	11.6 kg / 25.5 lb
Gross weight	Console w/ KVM	17.5 kg / 38.5 lb

Mounting Distance	
Console w/ KVM drawer	490 ~ 800 mm 19.3 ~ 31.5 inch

## OPTIONS:

- HDMI 1.3 / DP 1.0 video input
- 3G / HD / SD-SDI Broadcast-grade input
- Composite ( BNC )
- Audio input & output
- DC power : 12V / 24V / 48V / 125V
- MAC or SUN Micro keyboard options available
- Touchscreen : Resistive 1-pt

Video Option		
Digital	HDMI	HDMI 1.3 / HDCP 1.1
	Display port	DP 1.0 / HDCP 1.3
Analog	Composite ( BNC )	NTSC & PAL

Audio Option		
Input	Connector	3.5mm stereo jack
	Impedance / Power level	30kQ / 750mV
Output	Connector	3.5mm stereo jack
	Resistance / Power level	30kQ / 2.8V
Speaker	Dual stereo	2W x 2

Power		
Consumption (console / KVM)	Screen on	Max. 39W / Max. 112W
	Power saving mode	Max. 2W / Max. 36W
	Power button off	Max. 1W / Nil

Environment	
Operating temp.	0 to 55°C degree
Storage temp.	-20 to 60°C degree
Operating humidity	20~90%, non-condensing
Storage humidity	5 ~90%, non-condensing
Operating altitude	16,000 ft
Non-operating altitude	40,000 ft
Shock	10G acceleration ( 11ms duration )
Vibration	10~300Hz 0.5G RMS random vibration

Compliance	
EMC	FCC, CE & CCC certified
Safety	c UL us, CE / LVD & CCC certified
Environment	RoHS2 & REACH compliant

## 2K HDMI KVM

<b>2K KVM</b>		<b>Remote</b>	<b>8-port</b>
	0	0	NPW117-8K

## 2K KVM Cable



**N2K-6D ( 6 ft )**  
DVI-D KVM cable  
6ft 2K 60Hz

**N2K-6H ( 6 ft )**  
HDMI KVM cable  
6ft 2K 60Hz

Resolution : 16:9 - max. 2560 x 1440  
Support \*\*: 16:10 - max. 1920 x 1200  
4:3 - max. 1600 x 1200

Local Console	
Keyboard / Mouse :	2 x USB-A
Video :	1 x HDMI 1.4
Resolution :	16 : 9 - max. 2560 x 1440@60Hz
	16 : 10 - max. 1920 x 1200@60Hz
	4 : 3 - max. 1600 x 1200@60Hz

## KVM FEATURES

- 2K KVM with 8 HDMI USB ports in 1U
- 2K KVM cables support DP & HDMI video input
- Local console & KVM ports support resolution 2K and 1080p.
- Multi-platform for PC, server, blade server & SUN / MAC
- Port switching via front button & keyboard hotkeys
- Hot pluggable, no software or drivers required

## OPTIONS

DC power options: 12V / 24V / 48V / 125V

KVM Port	
Port # :	8
Connector :	HDMI 1.4 + USB-B ( Video + KB / MS )
Resolution :	16 : 9 - max. 2560 x 1440@60Hz
	16 : 10 - max. 1920 x 1200@60Hz
	4 : 3 - max. 1600 x 1200@60Hz

## LOCAL CONSOLE & KVM PORT CONNECTION

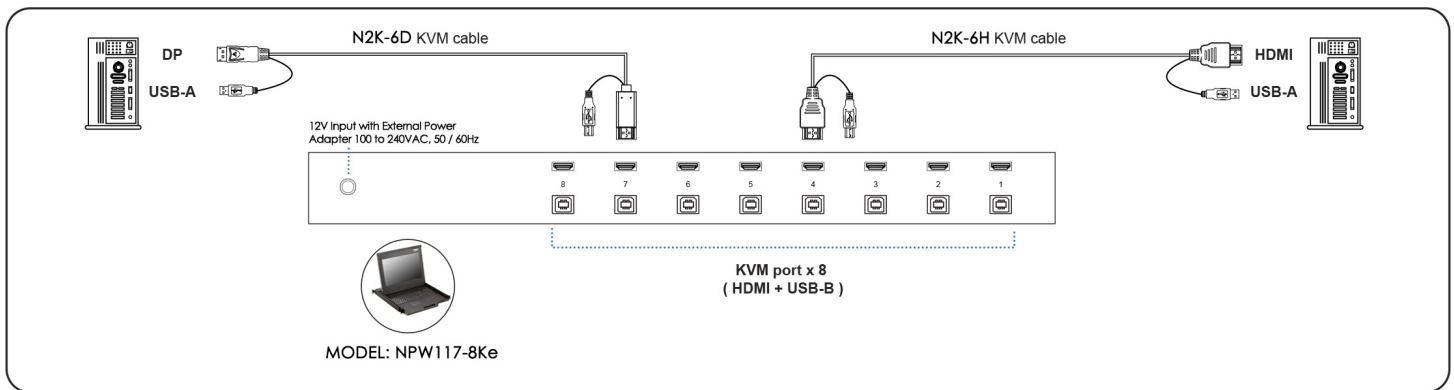

Management	
Port switching	Front button & keyboard hotkeys
Compatibility	
Hardware	HP / IBM / Dell PC, Server and Blade Server SUN / Mac
OS support	Windows / Linux / Unix / Mac OS
Environment	
Operating temp.	0 to 55°C degree
Storage temp.	-20 to 60°C degree
Operating humidity	20~90%, non-condensing
Operating altitude	16,000 ft
Non-operating altitude	40,000 ft
Shock	10G acceleration ( 11ms duration )
Vibration	10~300Hz 0.5G RMS random vibration

Power	
Input	Auto-sensing 100 to 240VAC, 50 / 60Hz
Consumption	Max. 10W
Compliance	
Safety	FCC & CE certified
Environment	RoHS2 & REACH compliant

## STANDARD KEYBOARD



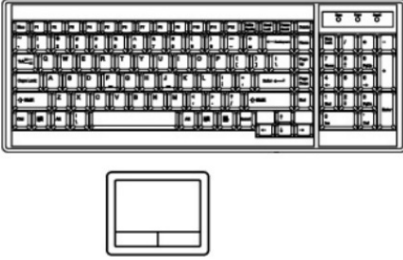





**e** keyboard integrated with touchpad



**b** keyboard integrated with trackball



### Supporting layouts

America					
	United States				
EMEA					
	United Kingdom	Germany	France	Spain	Italy
Asia					
	Japan	Korea			

## KEYBOARD OPTIONS (US layout only)

**Me** Mac keyboard with touchpad



**Se** S keyboard with touchpad

**Mb** Mac keyboard with trackball

**Sb** S keyboard with trackball

