

1U 17" Sunlight Readable FHD LCD Console Drawer 1920x1080 1000nits 8-Ports 2K HDMI USB KVM, 104 key keyboard w/ trackball.

Model: NPW117-8Kb



BENEFITS:

- 1U 17" LCD console drawer
- Front USB hub port for device access
- 1920 x 1080 native resolution / 16.7M colors (8-bit) / 1000 cd/m² brightness
- 104-key keyboard with either touchpad or trackball
- One Man installation design
- New enhanced aesthetics with molded front handle
- 2-year standard warranty (upgradable up to 5 years)

SPECIFICATIONS

LCD Panel	
Panel size (diagonal)	17.3"
Native resolution	1920 x 1080
Brightness (cd/m ²)	1000
Contrast ratio (typ.)	600 : 1
Colors	16.7 M, 8-bit
Viewing angle (L/R/U/D)	80/80/60/80
Response time (ms)	5.5
Dot pitch (mm)	0.1989
Display area (mm)	381.888H x 214.812V
Surface treatment	Anti-glare, Hard-coating
Surface hardness	3H
Backlight type	LED
MTBF (hrs)	50,000

Physical		
Product (WxDxH)	Console w/ KVM	442 x 580 x 44 mm 17.4 x 22.8 x 1.73 inch
Packing (WxDxH)	Console w/ KVM	590 x 808 x 140 mm 23.2 x 31.8 x 5.5 inch
Net weight	Console w/ KVM	11.6 kg / 25.5 lb
Gross weight	Console w/ KVM	17.5 kg / 38.5 lb

Mounting Distance	
Console w/ KVM drawer	490 ~ 800 mm 19.3 ~ 31.5 inch

OPTIONS:

- HDMI 1.3 / DP 1.0 video input
- 3G / HD / SD-SDI Broadcast-grade input
- Composite (BNC)
- Audio input & output
- DC power : 12V / 24V / 48V / 125V
- MAC or SUN Micro keyboard options available
- Touchscreen : Resistive 1-pt

Video Option		
Digital	HDMI	HDMI 1.3 / HDCP 1.1
	Display port	DP 1.0 / HDCP 1.3
Analog	Composite (BNC)	NTSC & PAL

Audio Option		
Input	Connector	3.5mm stereo jack
	Impedance / Power level	30kQ / 750mV
Output	Connector	3.5mm stereo jack
	Resistance / Power level	30kQ / 2.8V
Speaker	Dual stereo	2W x 2

Power		
Consumption (console / KVM)	Screen on	Max. 39W / Max. 112W
	Power saving mode	Max. 2W / Max. 36W
	Power button off	Max. 1W / Nil

Environment	
Operating temp.	0 to 55°C degree
Storage temp.	-20 to 60°C degree
Operating humidity	20~90%, non-condensing
Storage humidity	5 ~90%, non-condensing
Operating altitude	16,000 ft
Non-operating altitude	40,000 ft
Shock	10G acceleration (11ms duration)
Vibration	10~300Hz 0.5G RMS random vibration

Compliance	
EMC	FCC, CE & CCC certified
Safety	c UL us, CE / LVD & CCC certified
Environment	RoHS2 & REACH compliant

*Specifications subject to change without notice, not responsible for typographical errors.

2K HDMI KVM

2K KVM		Remote	8-port
	0	0	NPW117-8K

2K KVM Cable



N2K-6D (6 ft) **N2K-6H (6 ft)**
 DVI-D KVM cable HDMI KVM cable
 6ft 2K 60Hz 6ft 2K 60Hz

Resolution 16:9 - max. 2560 x 1440
 Support **: 16:10 - max. 1920 x 1200
 4:3 - max. 1600 x 1200

Local Console	
Keyboard / Mouse :	2 x USB-A
Video :	1 x HDMI 1.4
Resolution :	16 : 9 - max. 2560 x 1440@60H
	16 : 10 - max. 1920 x 1200@60Hz
	4 : 3 - max. 1600 x 1200@60Hz

KVM FEATURES

- 2K KVM with 8 HDMI USB ports in 1U
- 2K KVM cables support DP & HDMI video input
- Local console & KVM ports support resolution 2K and 1080p.
- Multi-platform for PC, server, blade server & SUN / MAC
- Port switching via front button & keyboard hotkeys
- Hot pluggable, no software or drivers required

OPTIONS

DC power options: 12V / 24V / 48V / 125V

KVM Port	
Port # :	8
Connector :	HDMI 1.4 + USB-B (Video + KB / MS)
Resolution :	16 : 9 - max. 2560 x 1440@60Hz
	16 : 10 - max. 1920 x 1200@60Hz
	4 : 3 - max. 1600 x 1200@60Hz

LOCAL CONSOLE & KVM PORT CONNECTION

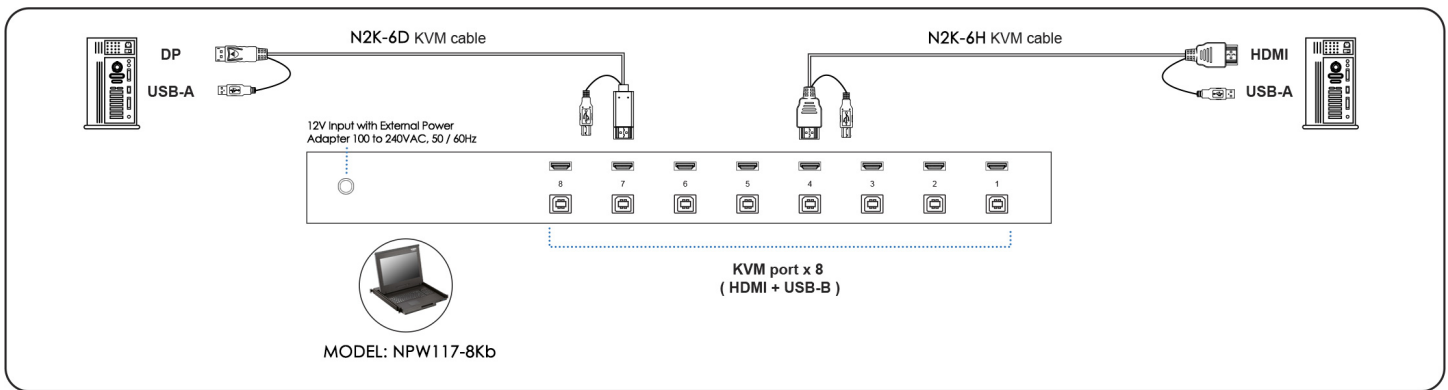

Management	
Port switching	Front button & keyboard hotkeys
Compatibility	
Hardware	HP / IBM / Dell PC, Server and Blade Server SUN / Mac
OS support	Windows / Linux / Unix / Mac OS
Environment	
Operating temp.	0 to 55°C degree
Storage temp.	-20 to 60°C degree
Operating humidity	20~90%, non-condensing
Operating altitude	16,000 ft
Non-operating altitude	40,000 ft
Shock	10G acceleration (11ms duration)
Vibration	10~300Hz 0.5G RMS random vibration

Power	
Input	Auto-sensing 100 to 240VAC, 50 / 60Hz
Consumption	Max. 10W
Compliance	
Safety	FCC & CE certified
Environment	RoHS2 & REACH compliant

STANDARD KEYBOARD



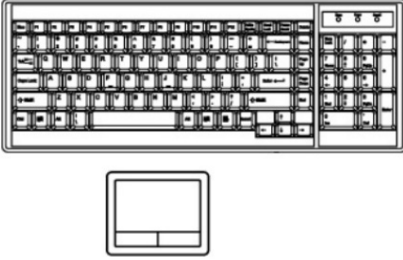





e keyboard integrated with touchpad



b keyboard integrated with trackball



Supporting layouts

America					
	United States				
EMEA					
	United Kingdom	Germany	France	Spain	Italy
Asia					
	Japan	Korea			

KEYBOARD OPTIONS (US layout only)

Me Mac keyboard with touchpad



Se S keyboard with touchpad

Mb Mac keyboard with trackball

Sb S keyboard with trackball

