

DRX Series

1U Dual Slide 17" Widescreen LCD Console Drawer, 1920x1200 WUXGA resolution, 104-key keyboard with touchpad, Full HD 1080p Resolution, with 8-Ports 2K HDMI USB KVM

Model: DRX117-8Ke



FEATURES:

- 1U dual slide 17" LCD Widescreen console drawer
- 104-key keyboard with touchpad
- One Man installation design
- 8-port HDMI, USB & Audio KVM
- Enhanced aesthetics with new molded front panel and two point lock
- Support widescreen & native SUN 1152 x 900 resolution

SPECIFICATIONS:

LCD Panel	
Diagonal size	17" Widescreen TFT
Max. Resolution	1920 x 1200
Brightness (cd/m2)	210
Backlight	LED
Colors	16.7M, 8-bit
Contrast Ratio (typ)	600 : 1
Viewing Angle (H/V)	130° x 110°
Active area (mm)	367 x 230
MTBF (hrs)	20,000
Casing Color	Black (RAL 9005)
Environmental	
Operating	0 to 50°C Degree
Storage	-5 to 60°C Degree
Relative humidity	5~90%, non-condensing
Shock	10G acceleration (11 ms duration)
Vibration	5~500Hz 1G RMS random vibration
Regulatory	
Safety	FCC & CE certified
Environmental	RoHS2 & REACH Compliant
Power	
Input	Auto-sensing 100 to 240VAC, 50 / 60Hz
Consumption	Max. 48 Watt, Standby 5 Watt

*Specifications subject to change without notice, not responsible for typographical errors.

2K HDMI KVM

2K KVM		Remote	8-port
	0	0	DRX117-8Ke

2K KVM Cable



N2K-6D (6 ft)
DVI-D KVM cable
6ft 2K 60Hz

N2K-6H (6 ft)
HDMI KVM cable
6ft 2K 60Hz

Resolution Support ** : 16:9 - max. 2560 x 1440
16:10 - max. 1920 x 1200
4:3 - max. 1600 x 1200

Local Console	
Keyboard / Mouse :	2 x USB-A
Video :	1 x HDMI 1.4
Resolution :	16 : 9 - max. 2560 x 1440@60Hz
	16 : 10 - max. 1920 x 1200@60Hz
	4 : 3 - max. 1600 x 1200@60Hz

KVM FEATURES

- 2K KVM with 8 HDMI USB ports in 1U
- 2K KVM cables support DP & HDMI video input
- Local console & KVM ports support resolution 2K and 1080p.
- Multi-platform for PC, server, blade server & SUN / MAC
- Port switching via front button & keyboard hotkeys
- Hot pluggable, no software or drivers required

KVM Port	
Port # :	8
Connector :	HDMI 1.4 + USB-B (Video + KB / MS)
Resolution :	16 : 9 - max. 2560 x 1440@60Hz
	16 : 10 - max. 1920 x 1200@60Hz
	4 : 3 - max. 1600 x 1200@60Hz

LOCAL CONSOLE & KVM PORT CONNECTION

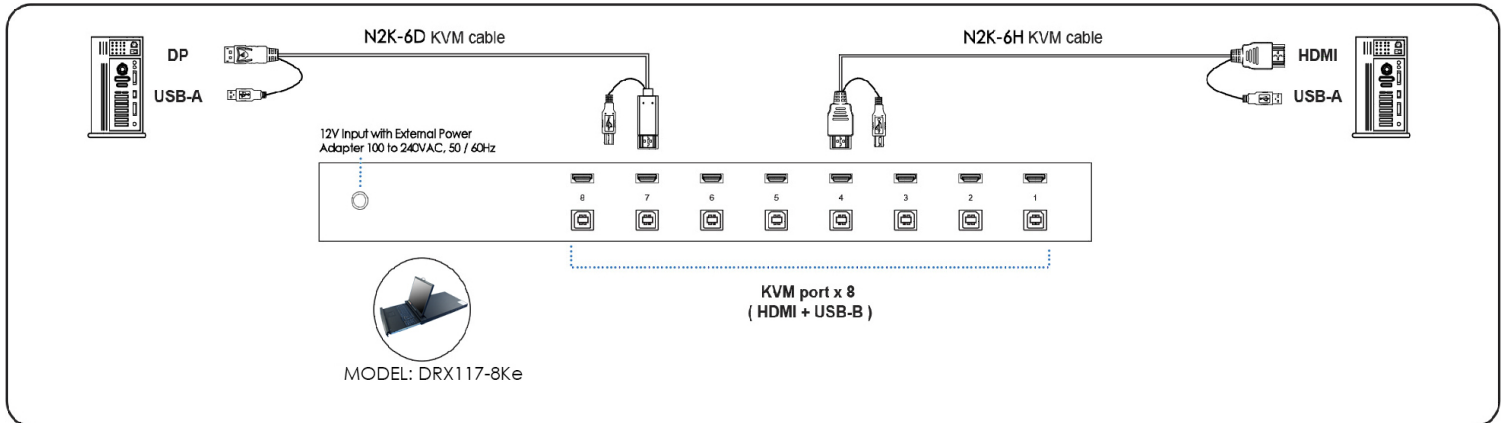

Management	
Port switching	Front button & keyboard hotkeys
Compatibility	
Hardware	HP / IBM / Dell PC, Server and Blade Server SUN / Mac
OS support	Windows / Linux / Unix / Mac OS
Environment	
Operating temp.	0 to 55°C degree
Storage temp.	-20 to 60°C degree
Operating humidity	20~90%, non-condensing
Operating altitude	16,000 ft
Non-operating altitude	40,000 ft
Shock	10G acceleration (11ms duration)
Vibration	10~300Hz 0.5G RMS random vibration







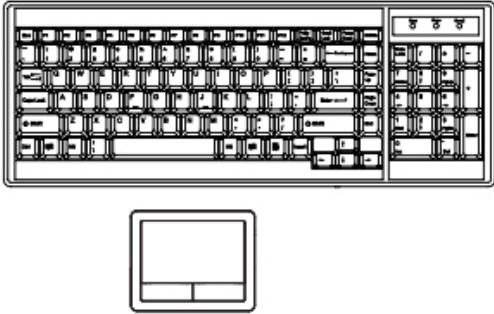

Power	
Input	Auto-sensing 100 to 240VAC, 50 / 60Hz
Consumption	Max. 10W
Compliance	
Safety	FCC & CE certified
Environment	RoHS2 & REACH compliant

STANDARD KEYBOARD

e keyboard integrated with touchpad



Supporting layouts

America					
	United States				
EMEA					
	United Kingdom	Germany	France	Spain	Italy
Asia					
	Japan	Korea			

KEYBOARD OPTIONS (US layout only)

Me Mac keyboard with touchpad



Se S keyboard with touchpad

