

Rugged 21.5" Aluminum Bezel Multi-Touch Monitor, 1920x1200 FHD, 1 xVGA, 1 xDP, 1 xHDMI, 1 xUSB for Touch, 1 xDC (or AC) connector with Mil. Circular Connector

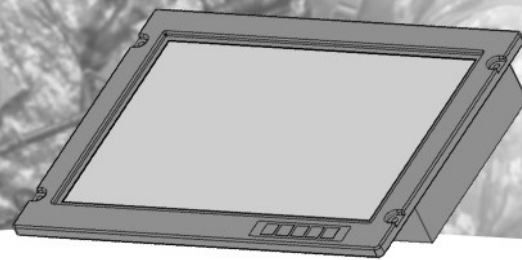

Model: NmiIW1700-PCAP

SPECIFICATIONS:

Housing	Front Bezel	Mil. grade aluminum alloy narrow bezel
	Chassis	Galvanized steel with anti-corrosion coating
	Color	Semi gloss finish in black
Mount	Front Mount	Support Front Mount
	VESA Mount	No (optional)
LCD Module	LCD Size	17" TFT LCD
	Resolution	1920 x 1200
	Brightness	800~900 cd/m2
	Contrast Ratio	600 : 1
	Display Color	16.7 M
	View Angle	70° / 70 / 60 / 60°
Touch	Touch Technology	Multi Projected Capacitive Touch
	Touch Point	Up to 10 Touch Points
	Touch Interface	USB
I/O Port	1 x VGA, 1 x HDMI, 1 x DP	
	USB	1 x USB for touch
	Power input	1 x DC or AC with circular connector
Power Supply	Power Input	DC 9~32V input
	Optional Power Input	AC90~264V
	Power Consumption	Around 30~35 Watts
Dimensions	Exclude Bezel	440 (W) x 312 (H) x 66 (D) mm
	Include Bezel	440 (W) x 312 (H) x 78 (D) mm
O. S.	Operating System	Support Linux, RHEL, Windows 7, 8, 10
Environmental	Operating Temperature	0 to +50° C
	Storage Temperature	-20 to + 75° C
	Humidity	5~95% R.H. at 35°C, non-condensing
	Shock	Design to meet MIL-STD-901D
	Vibration	Design to meet MIL-STD-167-1A
	Note : Test cost is required if test report is requested.	

**Specifications subject to change without notice, not responsible for typographical errors.*

MECHANICAL DRAWINGS:

This is subject to change without Notice. Final Drawings Will be Provided for Approval after Order.

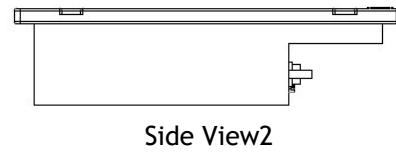
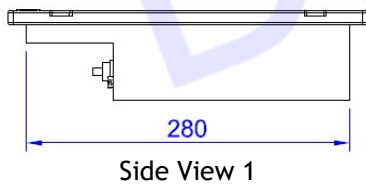
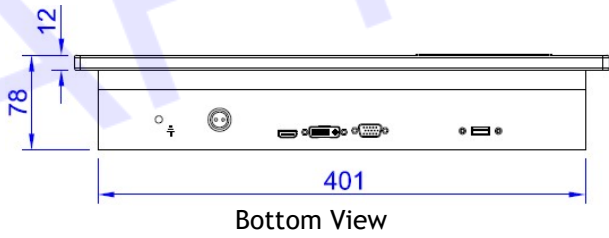
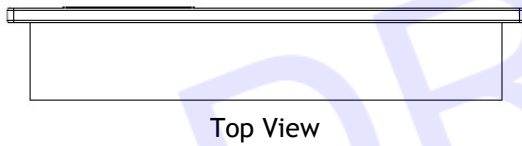
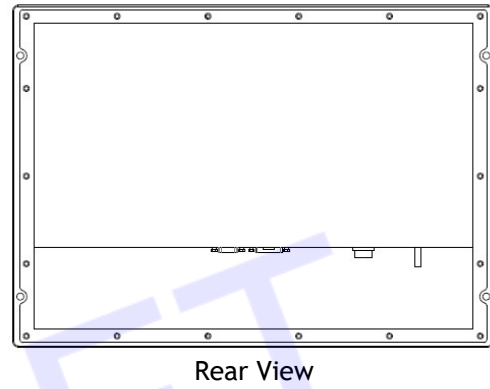
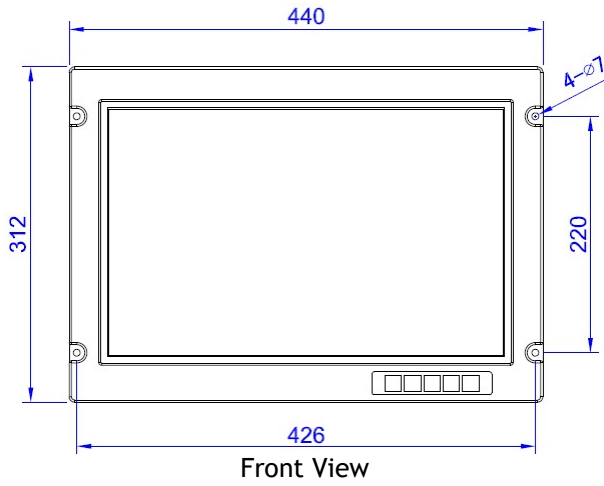

1 x VGA, 1 x HDMI, 1 x DP

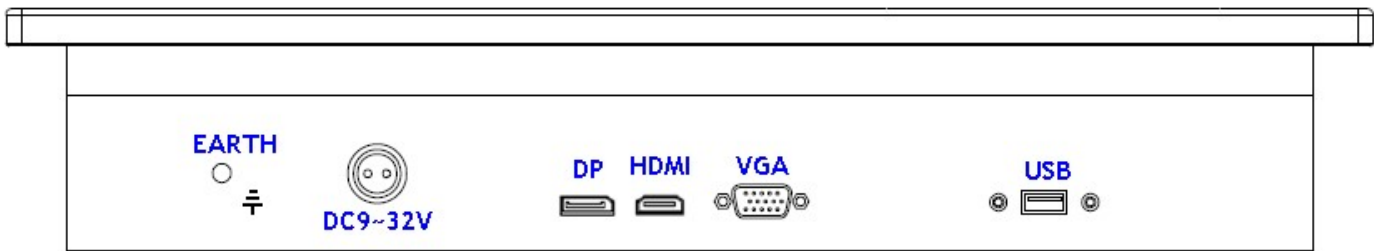

Video Ports Options

Drawing No.: NmiIW1700-PCAP-04112022-V1