

FANLESS Touch Panel PC

15" 1024x768, 1000nits Sunlight Readable
Industrial Fanless Panel PC with 7th Gen Intel Core i7 7600U
IP65 Silver Aluminum Front Bezel, 5 Wires Resistive Touch



Model: KPC1500HB-i7-TR



FEATURES:

- Fanless and rugged design
- 7th Gen Intel Core i7 7600U CPU
- Resolution 1024 x 768 dpi
- 5 Wires Resistive touch solution
- IP65 Silver Aluminum front bezel
- 4 x USB, 2 x RS232, 2 x GLAN, 1 x HDMI, 1 x DP
- VESA mount & Panel mount & Clip mount

MECHANICAL DRAWINGS:

This is subject to change without Notice. Final Drawings Will be Provided for Approval after Order.

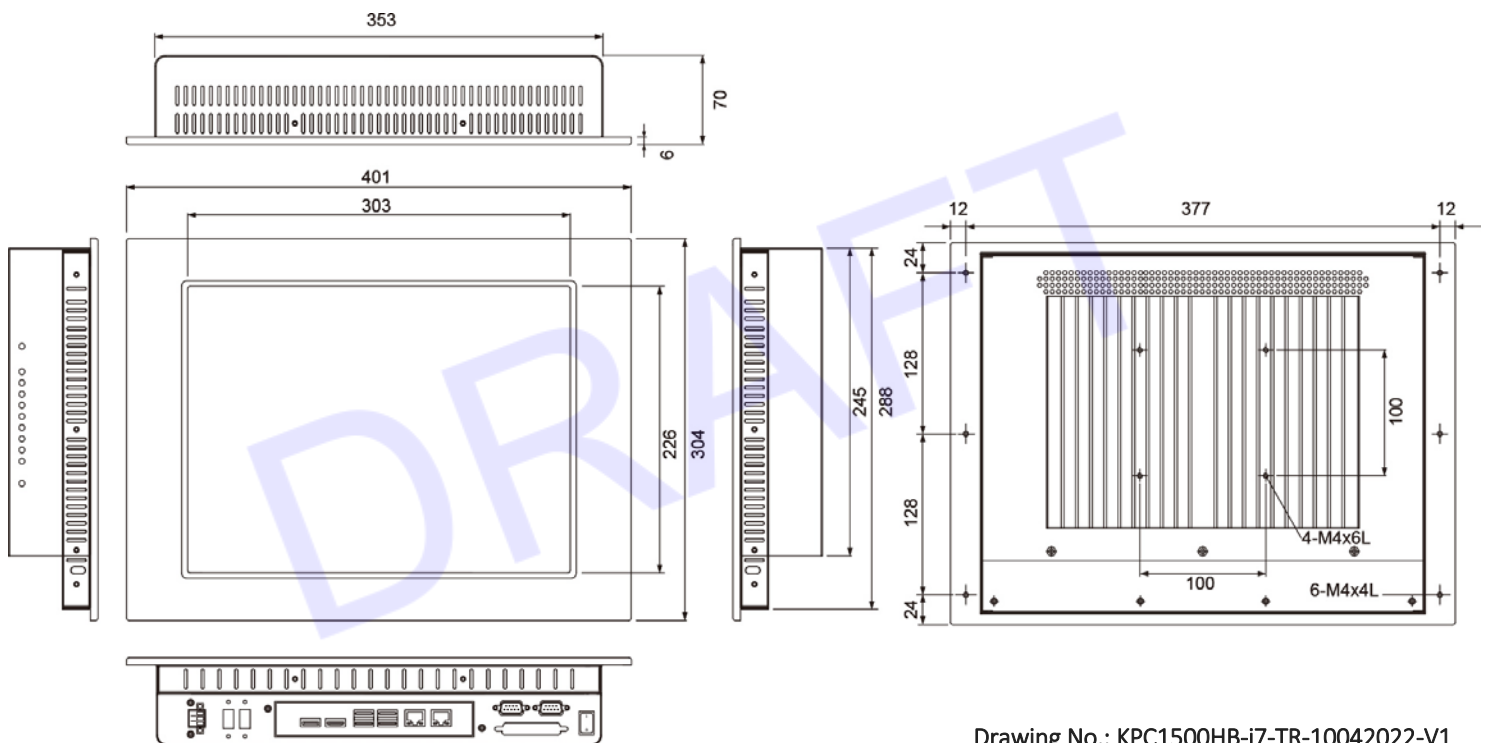

Drawing No.: KPC1500HB-i7-TR-10042022-V1

SPECIFICATIONS:

SYSTEM	
CPU	7th Gen Intel Core i7 7600U
Memory	1 x 260-pin DDR4 2133MHz SODIMM up to 16 GB
H/W MONITOR	
Watchdog Timer	Watch Dog Timer 256 Level
I/O PORTS	
RS232	2
HDMI	1
DP	1
USB	4
GLAN	2
STORAGE	
Storage	1 x SATA 3.0 2.5" HDD/SSD
EXPANSION	
Mini PCI-E	2 x Full size
POWER REQUIREMENT	
Power Requirement	3 Pin power terminal block for DC in 12 ~ 24V
TOUCH SCREEN	
Touch screen	5 Wires Resistive (one touch)
OS SUPPORT	
OS support	Win Pro 7, 8.1, 10 / Embedded Win 7, 8.1, 10 / Fedora 25 Ubuntu 16.04
DISPLAY	
Size	15" TFT (4:3)
Resolution	1024 x 768
Colors	16.2M
Luminance	1000 cd/m2
Contrast Ratio	2000 : 1
View Angle (HA/)	176° / 176°
MECHANICAL & ENVIRONMENTAL	
Operation Temp.	0 ~ 45°C
Storage Humidity	10 ~ 90%, non-condensing
Mount	VESA mount (100X100mm) & Panel mount & Clip mount
Dimension (WxHxD)	401 x 304 x 70 mm
Weight	5.7 kg
OPTIONAL	
External antenna (WIFI)	
1600 cd/m2 High Brightness 15" LCD panel 1024 x 768 dpi	
Optical Bonding	
10pcs x Clips	
1 x RS232/422/485	
Waterproof sponge	

**Specifications subject to change without notice, not responsible for typographical errors.*