

# FANLESS Touch Panel PC

15" 1024x768, 1000nits Sunlight Readable  
Industrial Fanless Panel PC with 7th Gen Intel Core i5 7300U  
IP65 Silver Aluminum Front Bezel, 5 Wires Resistive Touch



**Model: KPC1500HB-i5-TR**



## FEATURES:

- Fanless and rugged design
- 7th Gen Intel Core i5 7300U CPU
- Resolution 1024 x 768 dpi
- 5 Wires Resistive touch solution
- IP65 Silver Aluminum front bezel
- 4 x USB, 2 x RS232, 2 x GLAN, 1 x HDMI, 1 x DP
- VESA mount & Panel mount & Clip mount

## MECHANICAL DRAWINGS:

*This is subject to change without Notice. Final Drawings Will be Provided for Approval after Order.*

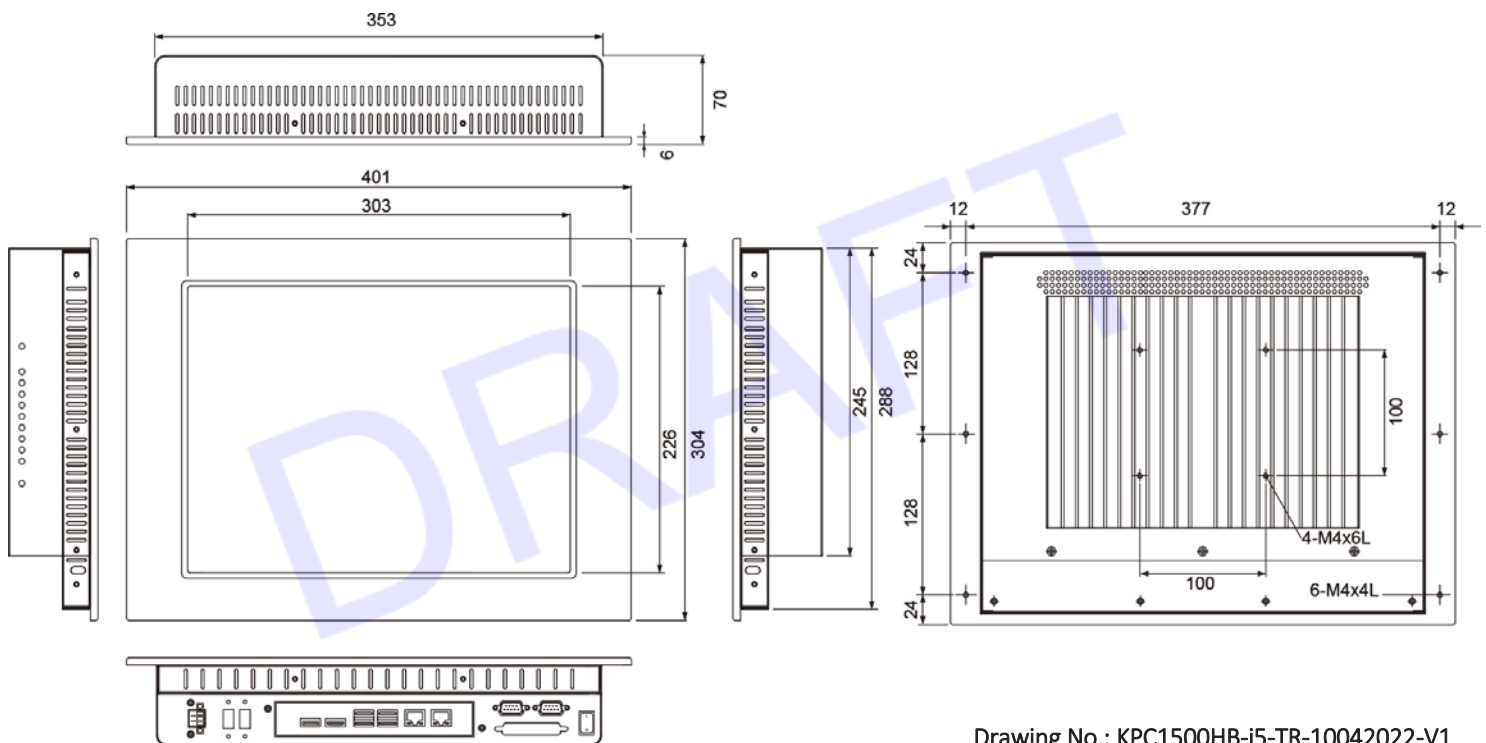

Drawing No.: KPC1500HB-i5-TR-10042022-V1

## SPECIFICATIONS:

<b>SYSTEM</b>	
CPU	7th Gen Intel Core i5 7300U
Memory	1 x 260-pin DDR4 2133MHz SODIMM up to 16 GB
<b>H/W MONITOR</b>	
Watchdog Timer	Watch Dog Timer 256 Level
<b>I/O PORTS</b>	
RS232	2
HDMI	1
DP	1
USB	4
GLAN	2
<b>STORAGE</b>	
Storage	1 x SATA 3.0 2.5" HDD/SSD
<b>EXPANSION</b>	
Mini PCI-E	2 x Full size
<b>POWER REQUIREMENT</b>	
Power Requirement	3 Pin power terminal block for DC in 12 ~ 24V
<b>TOUCH SCREEN</b>	
Touch screen	5 Wires Resistive (one touch)
<b>OS SUPPORT</b>	
OS support	Win Pro 7, 8.1, 10 / Embedded Win 7, 8.1, 10 / Fedora 25 Ubuntu 16.04
<b>DISPLAY</b>	
Size	15" TFT (4:3)
Resolution	1024 x 768
Colors	16.2M
Luminance	1000 cd/m2
Contrast Ratio	2000 : 1
View Angle (HA/)	176° / 176°
<b>MECHANICAL &amp; ENVIRONMENTAL</b>	
Operation Temp.	0 ~ 45°C
Storage Humidity	10 ~ 90%, non-condensing
Mount	VESA mount (100X100mm) & Panel mount & Clip mount
Dimension (WxHxD)	401 x 304 x 70 mm
Weight	5.7 kg
<b>OPTIONAL</b>	
External antenna ( WIFI )	
1600 cd/m2 High Brightness 15" LCD panel 1024 x 768 dpi	
Optical Bonding	
10pcs x Clips	
1 x RS232/422/485	
Waterproof sponge	

*\*Specifications subject to change without notice, not responsible for typographical errors.*