

Ultra Slim Panel PC



18.5" Ultra Slim Panel PC, Modular Design 1366x768 Intel i3-7020U, 4GB Memory, 128GB SSD (M.2) Storage with Windows 10 IoT Enterprise, Linux Operating System

Model: FCHW1850-i3



CUSTOMIZABLE

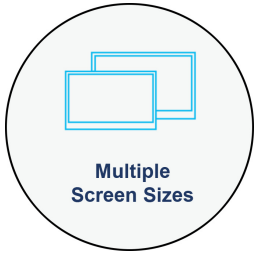

11.6"/15.6"/18.5"/21.5"



POS stand, Printer stand, Floor stand

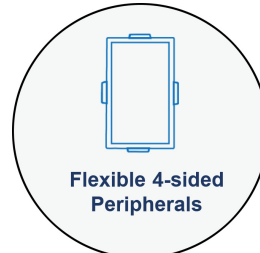

Fingerprint, 2D scanner
NFC, MSR, Light Bar, Camera

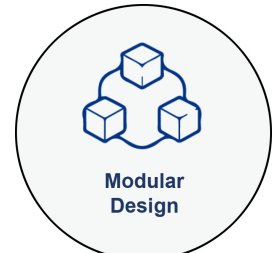

Removable Main board Box

SIZES 11.6" ~ 21.5"

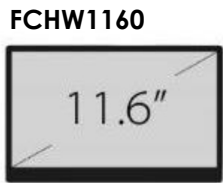

1920 x 1080

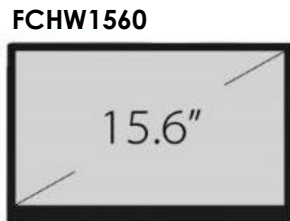

1920 x 1080



1366 x 768

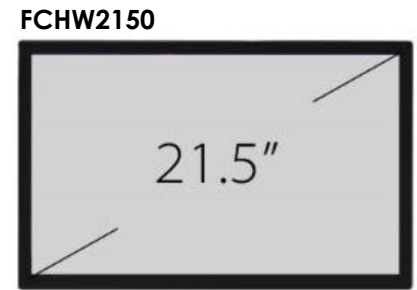

1920 x 1080

TRANSFORMABLE COMBINATIONS



Panel PC



POS Stand



Printer Stand



Floor Stand

LIMITLESS CONNECTION

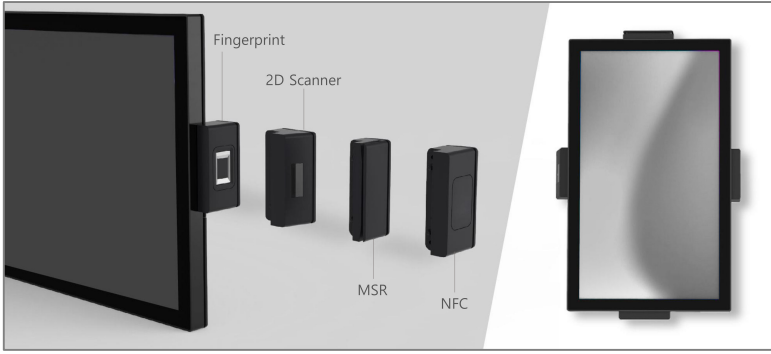

USER GUIDANCE BY RGB INDICATOR LIGHTING

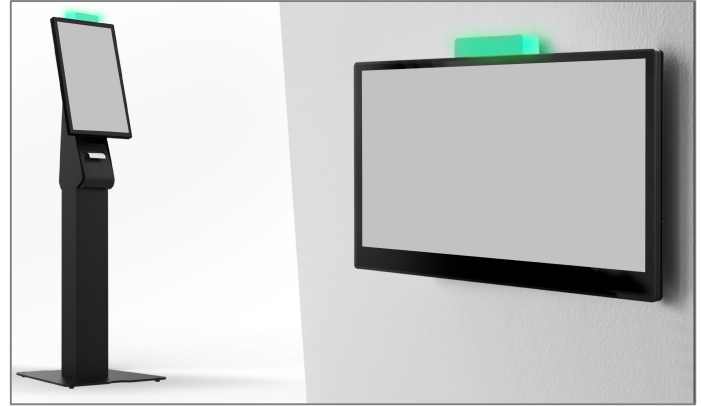

5M CAMERA MODULE

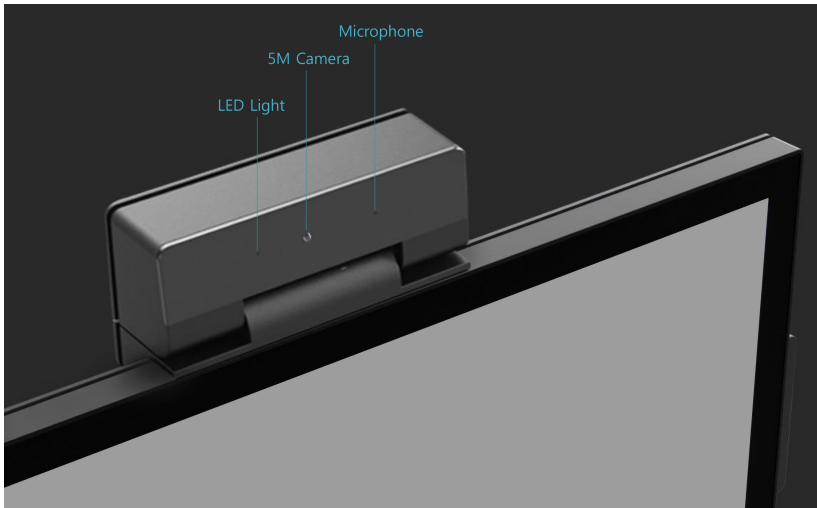

MODULARITY FOR EASY MAINTENANCE

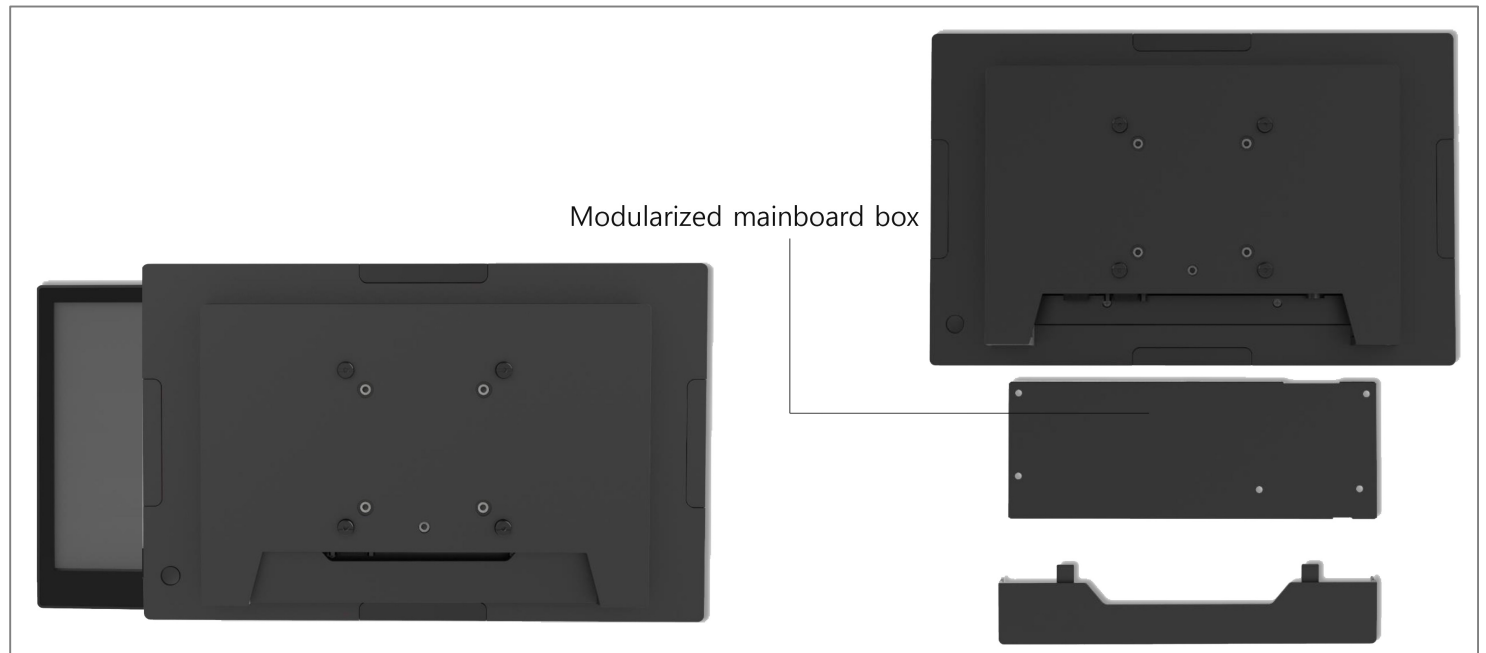

SPECIFICATIONS

System	Processor	Intel® i3-7020U
	Memory	4GB DDR4
	Storage	128GB SSD (M.2)
	Supported OS	Windows 10 IoT Enterprise, Linux
I/O Ports	USB	2x USB3.0 (Type C)
		2x USB3.0
		2x USB2.0
	Serial Port	2x DB9 (Powered RS232) (default: 0V; COM1/COM2: 0V, 5V,12V)
	LAN	1x RJ45
	Cash Drawer	1xRJ11
	FeDP	2x Flytech Proprietary miniDP
Display	DC Jack	1x4PIN DIN (with latch)
	Size and Resolution	18.5" 1366 x 768
	Brightness	300 nits
	Touch Screen	True-Flat PCAP multi-touch
Audio	Speaker	1x3W
Power	Power Supply	120W / 19V
Certificate	EMC & Safety	FCC Class A, CE Mark Class A, LVD
Environment	Operating Temperature	0°C ~ 35°C (32°F ~ 95°F)
	Storage Temperature	-20°C~60°C(-4°F~140°F)
	Humidity	20% ~ 85% RH non-condensing
Dimensions	WxDxH	453 x 273 x 50.2 mm (17.8" x 10.8" x 2")

Weight	Weight	4.4 kg (9.7 lbs)
Mounting	VESA Mount	75 x 75 / 100 x 100
Options	Wireless LAN + BT	WiFi+BT USB dongle
	POE	N/A
	MSR	3-Track MSR
	Fingerprint	Fingerprint Reader
	NFC	NFC Reader
	Scanner	2D Scanner
	Pin Pad	Supported Verifone® P400A/X805A/X820, Ingenico iPP 350/320, LANE 3000
	Cable	Converter cable for FeDP to VGA
		Converter cable for FeDP to H DM I
	Light Bar	Light Bar Module
	Stand	POS Stand, Printer Stand, Floor Stand
Printer Kit	Epson® TM-m30/TM-T88VI, Star TSP-654/TSP-100/mc-Print3, Xprinter XP-R330H	

**Specifications subject to change without notice, not responsible for typographical errors.*