

Ultra Slim Panel PC



15.6" Ultra Slim Panel PC, Modular Design 1920x1080
Qualcomm 450, 3GB Memory, 32GB Storage with Android
9.0 Operating System

Model: FCHW1560-AO-4



CUSTOMIZABLE

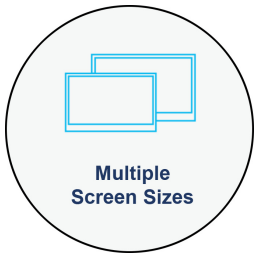

Multiple
Screen Sizes

11.6"/15.6"/18.5"/21.5"



Transformable
Stands

POS stand, Printer stand,
Floor stand

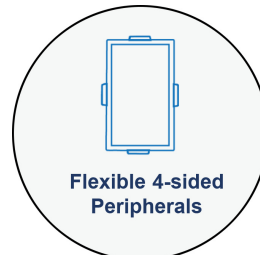

Flexible 4-sided
Peripherals

Fingerprint, 2D scanner
NFC, MSR, Light Bar, Camera

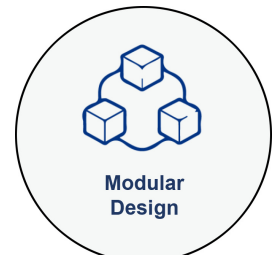

Modular
Design

Removable Main
board Box

SIZES 11.6" ~ 21.5"

FCHW1160



1920 x 1080

FCHW1560

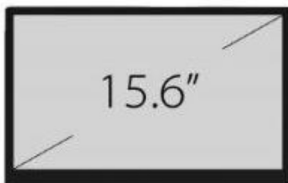

1920 x 1080

FCHW1850



1366 x 768

FCHW2150

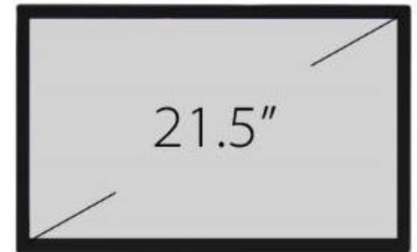

1920 x 1080

TRANSFORMABLE COMBINATIONS

Panel PC



POS Stand



Printer Stand



Floor Stand



LIMITLESS CONNECTION

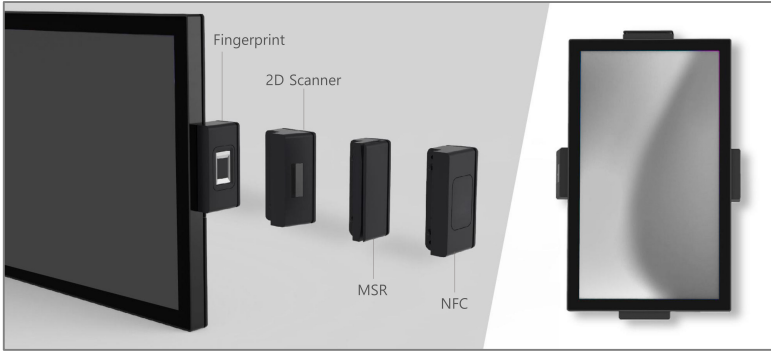

USER GUIDANCE BY RGB INDICATOR LIGHTING

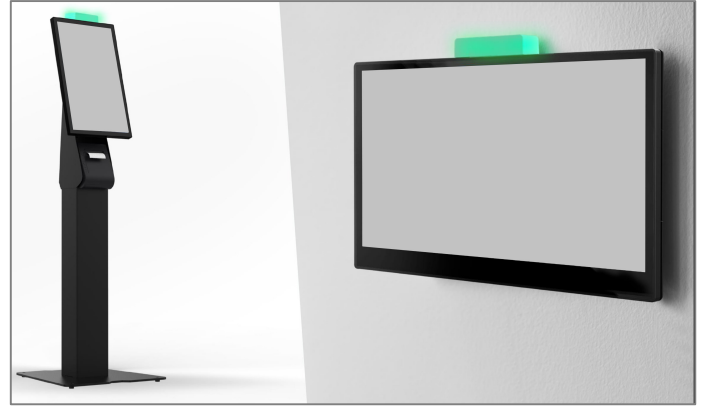

5M CAMERA MODULE

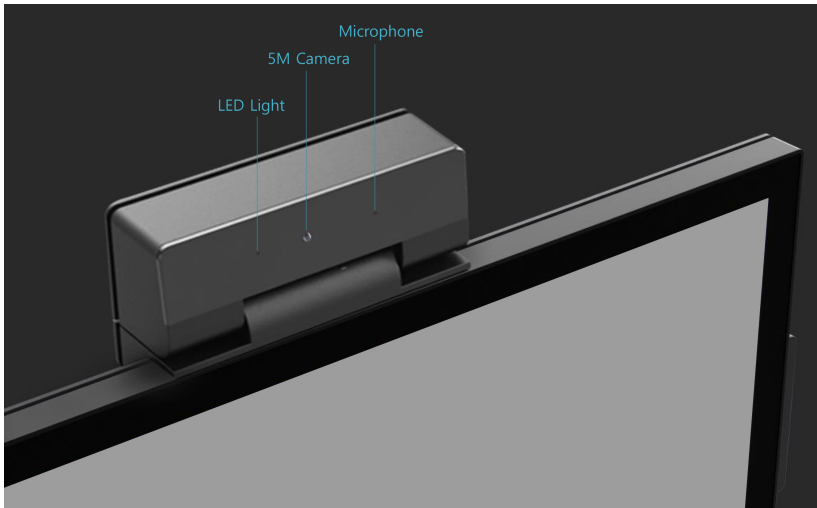

MODULARITY FOR EASY MAINTENANCE

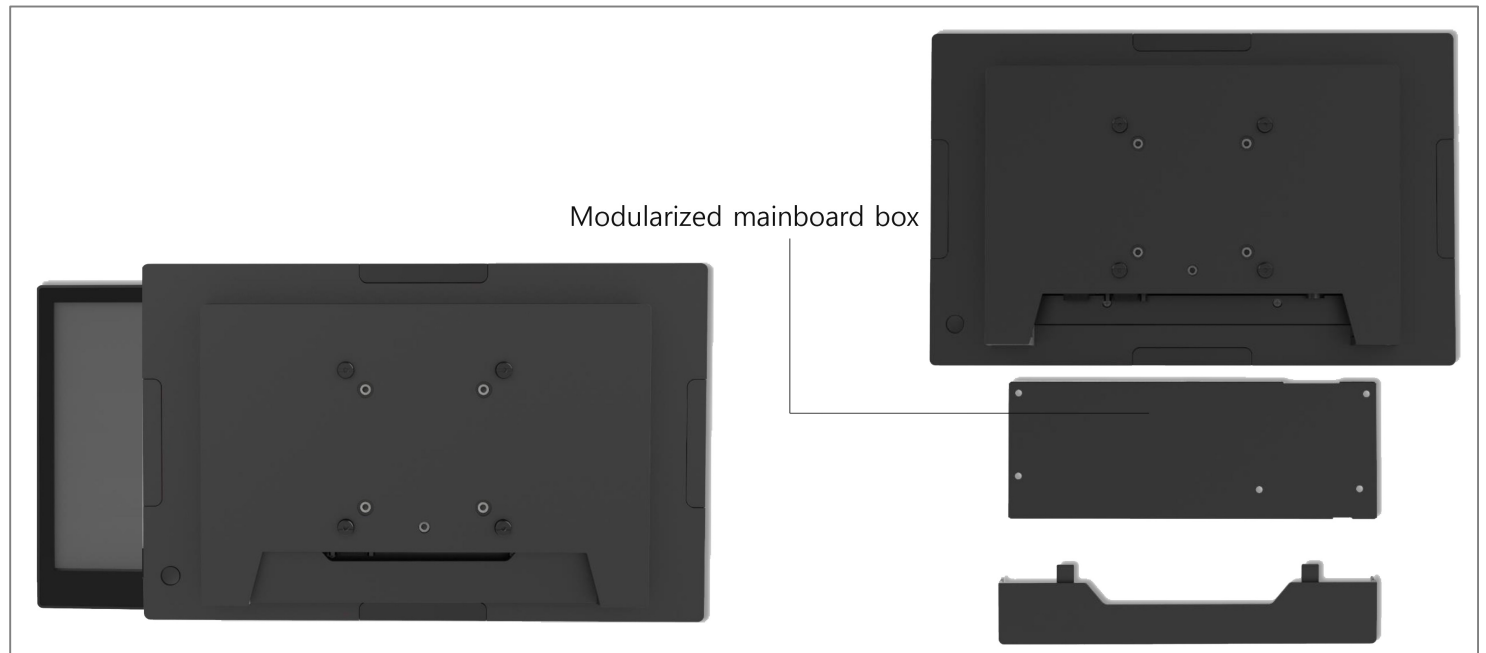

SPECIFICATIONS

System	Processor	Qualcomm® 450
	Memory	3GB LPDDR4
	Storage	32GB eMMC
	Supported OS	Android 9.0
I/O Ports	USB	1x USB3.0 (Type C)
		2x USB3.0
		2x USB2.0
	Serial Port	2x DB9 (Powered RS232) (default: 0V; COM1/COM2: 0V, 5V,12V)
	LAN	1x RJ45
	Cash Drawer	1xRJ11
	FeDP	2x Flytech Proprietary miniDP
Display	DC Jack	1x4PIN DIN (with latch)
	Size and Resolution	15.6" 1920x1080
	Brightness	300 nits
	Touch Screen	True-Flat PCAP multi-touch
Audio	Speaker	1x3W
Power	Power Supply	65W / 19V
Certificate	EMC & Safety	FCC Class A, CE Mark Class A, LVD
Environment	Operating Temperature	0°C ~ 35°C (32°F ~ 95°F)
	Storage Temperature	-20°C~60°C(-4°F~140°F)
	Humidity	20% ~ 85% RH non-condensing
Dimensions	WxDxH	370 x 235 x 42.3 mm (14.6" x 9.3" x 1.7")

Weight	Weight	3.0 kg (6.6 lbs)
Mounting	VESA Mount	75 x 75 / 100 x 100
Options	Wireless LAN + BT	BT4.1 WiFi 802.11 a/b/g/n/ac
	POE	POE module 802.3bt Type 3 (up to 60W)
	MSR	3-Track MSR
	Fingerprint	Fingerprint Reader
	NFC	N/A
	Scanner	2D Scanner
	Pin Pad	Supported Verifone® P400A/X805A/X820, Ingenico iPP 350/320, LANE 3000
	Cable	Converter cable for FeDP to VGA
		Converter cable for FeDP to H DM I
	Light Bar	Light Bar Module
	Stand	POS Stand, Printer Stand, Floor Stand
	Printer Kit	Epson® TM-m30/TM-T88VI, Star TSP-654/TSP-100/mc-Print3, Xprinter XP-R330H

***Specifications subject to change without notice, not responsible for typographical errors.**