

# Ultra Slim Panel PC



11.6" Ultra Slim Panel PC, Modular Design 1920x1080 Intel i3-7020U, 4GB Memory, 128GB SSD (M.2) Storage with Windows 10 IoT Enterprise, Linux Operating System

Model: FCHW1160-i3



## CUSTOMIZABLE

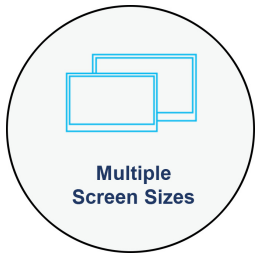

Multiple Screen Sizes

11.6"/15.6"/18.5"/21.5"



Transformable Stands

POS stand, Printer stand, Floor stand

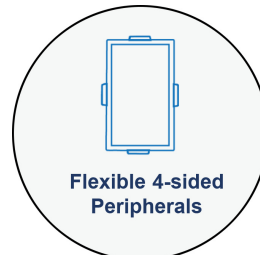

Flexible 4-sided Peripherals

Fingerprint, 2D scanner  
NFC, MSR, Light Bar, Camera

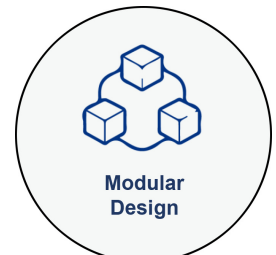

Modular Design

Removable Main board Box

## SIZES 11.6" ~ 21.5"

FCHW1160



1920 x 1080

FCHW1560

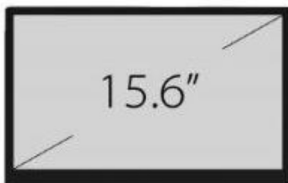

1920 x 1080

FCHW1850



1366 x 768

FCHW2150

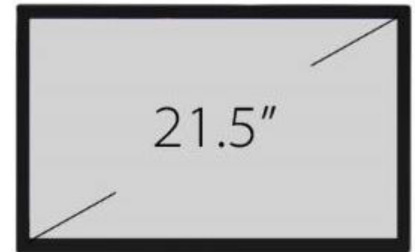

1920 x 1080

## TRANSFORMABLE COMBINATIONS

Panel PC



POS Stand



Printer Stand



Floor Stand



## LIMITLESS CONNECTION

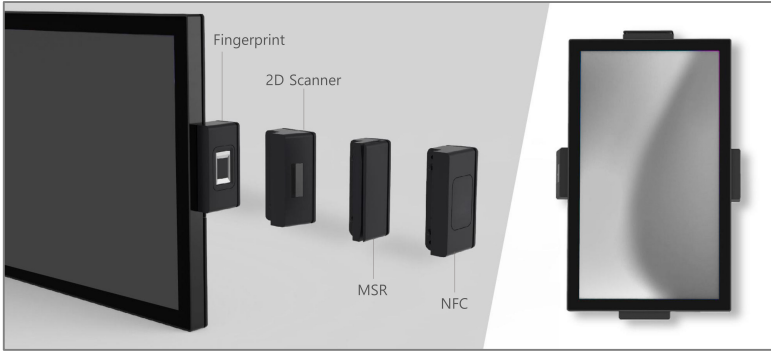

## USER GUIDANCE BY RGB INDICATOR LIGHTING

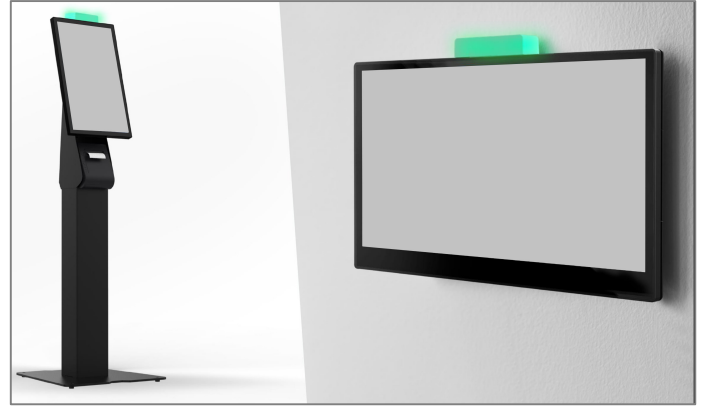

## 5M CAMERA MODULE

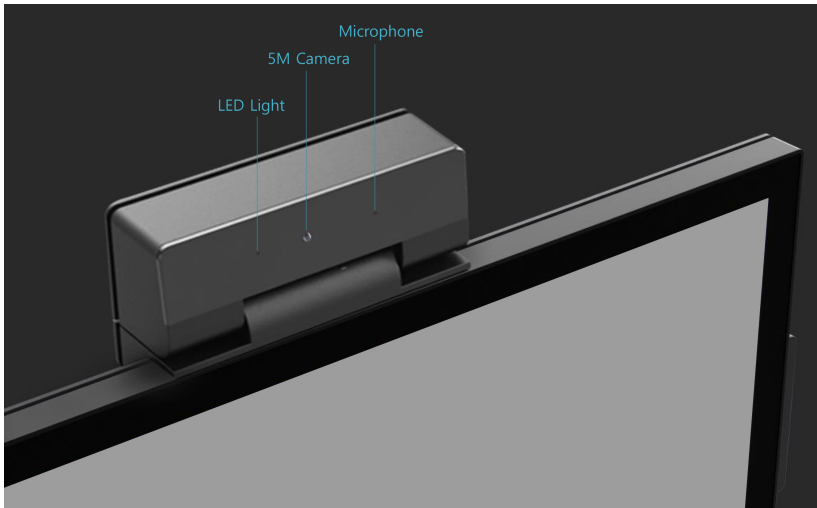

## MODULARITY FOR EASY MAINTENANCE

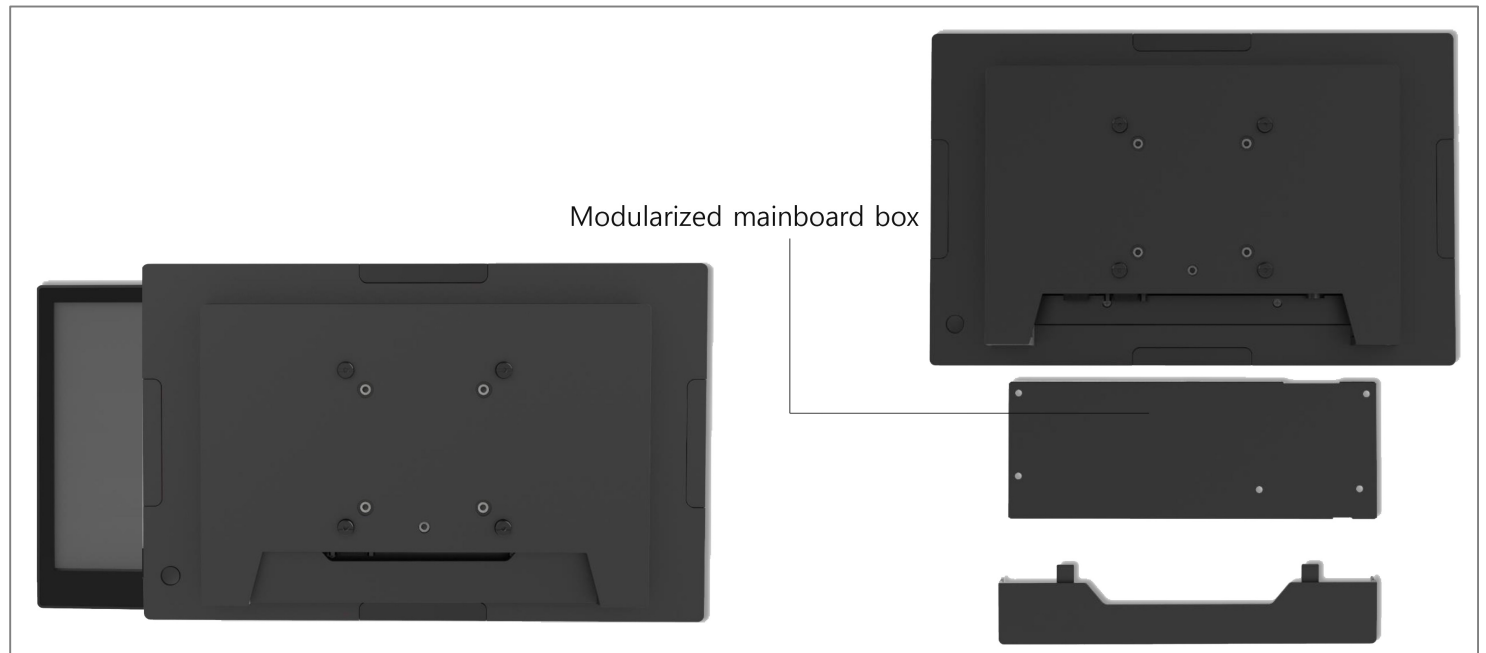

## SPECIFICATIONS

System	Processor	Intel® i3-7020U
	Memory	4GB DDR4
	Storage	128GB SSD (M.2)
	Supported OS	Windows 10 IoT Enterprise, Linux
I/O Ports	USB	2x USB3.0 (Type C)
		2x USB3.0
		2x USB2.0
	Serial Port	2x DB9 (Powered RS232) (default: 0V; COM1/COM2: 0V, 5V,12V)
	LAN	1x RJ45
	Cash Drawer	1xRJ11
	FeDP	1x Flytech Proprietary miniDP
Display	DC Jack	1x4PIN DIN (with latch)
	Size and Resolution	11.6" 1920x1080
	Brightness	300 nits
	Touch Screen	True-Flat PCAP multi-touch
Audio	Speaker	1x3W
Power	Power Supply	120W / 19V
Certificate	EMC & Safety	FCC Class A, CE Mark Class A, LVD
Environment	Operating Temperature	0°C ~ 35°C (32°F ~ 95°F)
	Storage Temperature	-20°C~60°C(-4°F~140°F)
	Humidity	20% ~ 85% RH non-condensing
Dimensions	WxDxH	277 x 180.5 x 40.8 mm (10.9" x 7.1" x 1.6")

Weight	Weight	1.4 kg (3.1 lbs)
Mounting	VESA Mount	75x75
Options	Wireless LAN + BT	M.2(E-key)/BT Module
	POE	NA
	MSR	3-Track MSR
	Fingerprint	Fingerprint Reader
	NFC	NFC Reader
	Scanner	2D Scanner
	Pin Pad	Supported Verifone® P400A/X805A/X820, Ingenico iPP 350/320, LANE 3000
	Cable	Converter cable for FeDP to VGA
		Converter cable for FeDP to H DM I
	Light Bar	Light Bar Module
	Stand	POS Stand, Printer Stand, Floor Stand
	Printer Kit	Epson® TM-m30/TM-T88VI, Star TSP-654/TSP-100/mc-Print3, Xprinter XP-R330H

*\*Specifications subject to change without notice, not responsible for typographical errors.*