

Ultra Slim Panel PC



11.6" Ultra Slim Panel PC, Modular Design 1920x1080 Intel Elkhart Lake Celeron J6412, 4GB Memory, 128GB SSD (M.2) Storage with Windows 10 IoT Enterprise, Linux Operating System

Model: FCHW1160-J



CUSTOMIZABLE

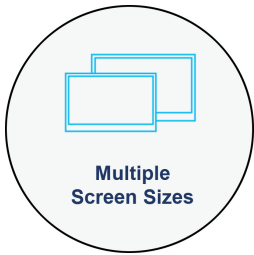

Multiple Screen Sizes

11.6"/15.6"/18.5"/21.5"



Transformable Stands

POS stand, Printer stand, Floor stand

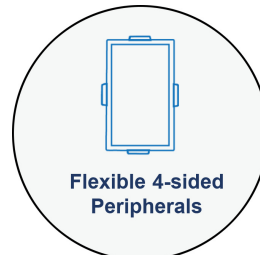

Flexible 4-sided Peripherals

Fingerprint, 2D scanner
NFC, MSR, Light Bar, Camera

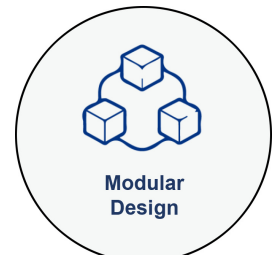

Modular Design

Removable Main board Box

SIZES 11.6" ~ 21.5"

FCHW1160



1920 x 1080

FCHW1560



1920 x 1080

FCHW1850



1366 x 768

FCHW2150

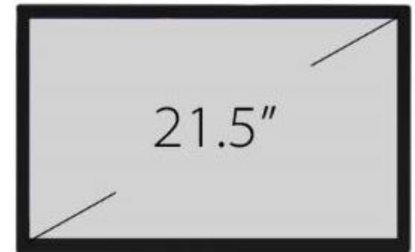

1920 x 1080

TRANSFORMABLE COMBINATIONS

Panel PC



POS Stand



Printer Stand



Floor Stand



LIMITLESS CONNECTION

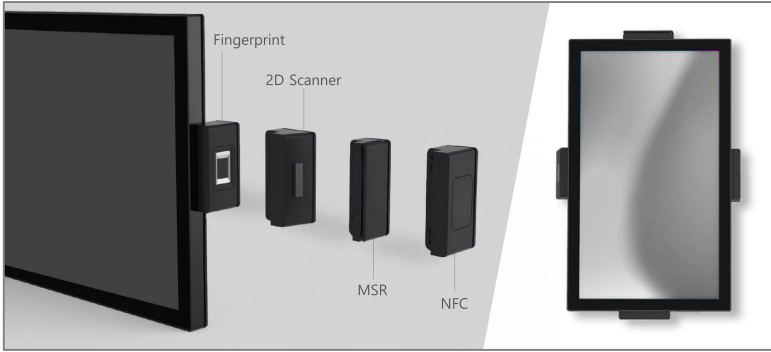

USER GUIDANCE BY RGB INDICATOR LIGHTING

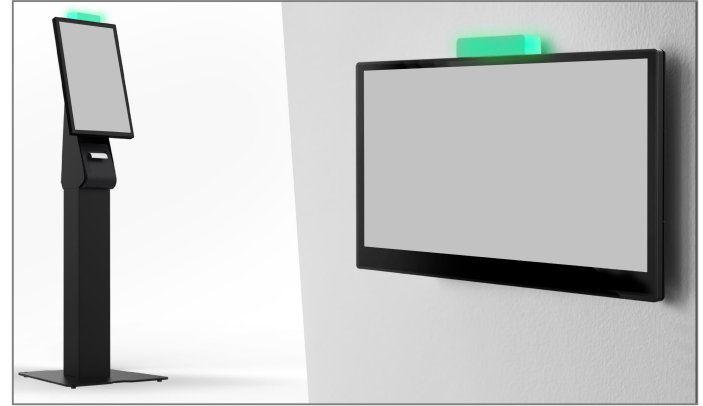

5M CAMERA MODULE

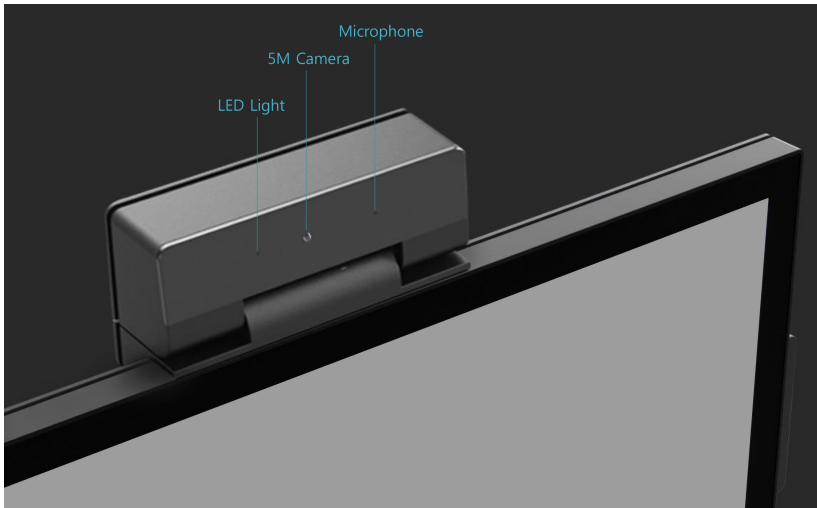

MODULARITY FOR EASY MAINTENANCE

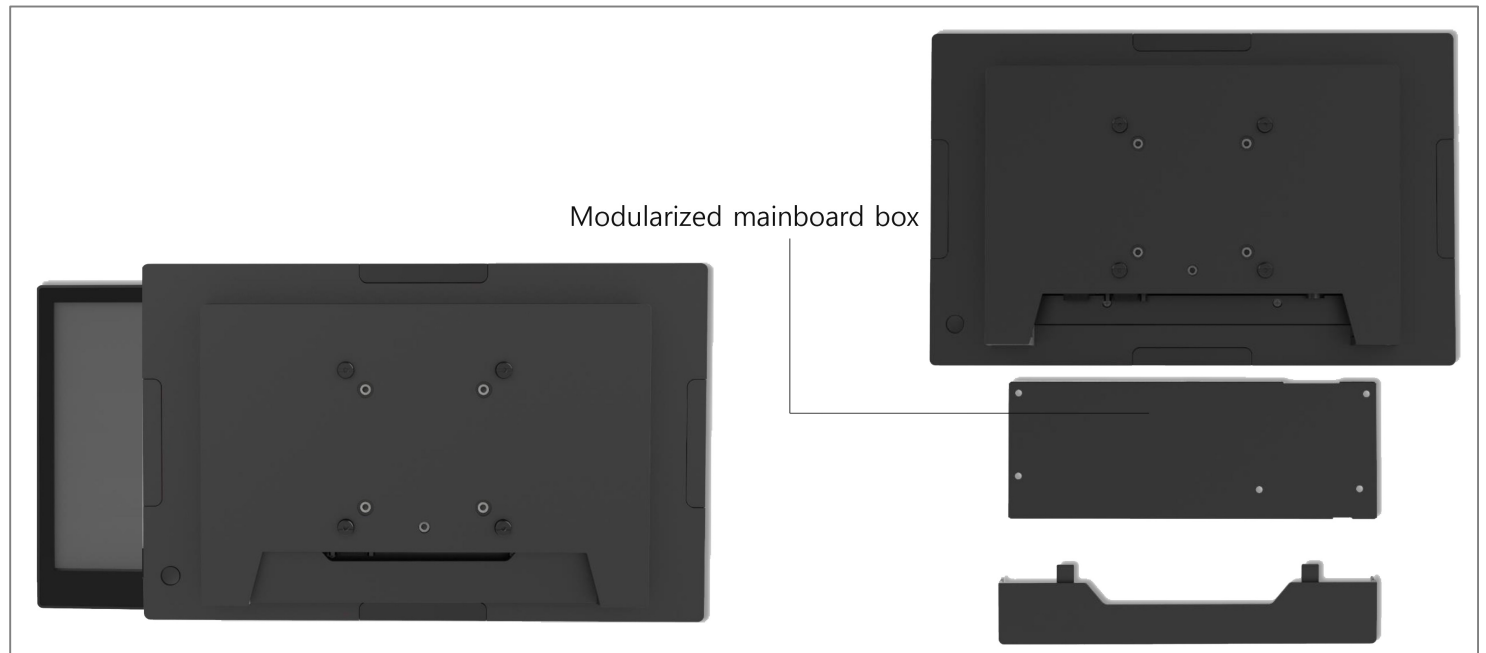

SPECIFICATIONS

System	Processor	Intel® Elkhart Lake Celeron J6412
	Memory	4GB DDR4
	Storage	128GB SSD (M.2)
	Supported OS	Windows 10 IoT Enterprise, Linux
I/O Ports	USB	1x USB2.0 (Type C) / 1x USB3.0 (Type C)
		2x USB3.0
		2x USB2.0
	Serial Port	2x DB9 (Powered RS232) (default: 0V; COM1/COM2: 0V, 5V, 12V)
	LAN	1x RJ45
	Cash Drawer	1xRJ11
	FeDP	1x Flytech Proprietary miniDP
Display	DC Jack	1x4PIN DIN (with latch)
	Size and Resolution	11.6" 1920x1080
	Brightness	300 nits
	Touch Screen	True-Flat PCAP multi-touch
Audio	Speaker	1x3W
Power	Power Supply	65W / 19V
Certificate	EMC & Safety	FCC Class A, CE Mark Class A, LVD
Environment	Operating Temperature	0°C ~ 35°C (32°F ~ 95°F)
	Storage Temperature	-20°C~60°C(-4°F~140°F)
	Humidity	20% ~ 85% RH non-condensing
Dimensions	WxDxH	277 x 180.5 x 40.8 mm (10.9" x 7.1" x 1.6")

Weight	Weight	1.4 kg (3.1 lbs)
Mounting	VESA Mount	75x75
Options	Wireless LAN + BT	M.2(E-key)/BT Module
	POE	NA
	MSR	3-Track MSR
	Fingerprint	Fingerprint Reader
	NFC	NFC Reader
	Scanner	2D Scanner
	Pin Pad	Supported Verifone® P400A/X805A/X820, Ingenico iPP 350/320, LANE 3000
	Cable	Converter cable for FeDP to VGA
		Converter cable for FeDP to H DM I
	Light Bar	Light Bar Module
	Stand	POS Stand, Printer Stand, Floor Stand
	Printer Kit	Epson® TM-m30/TM-T88VI, Star TSP-654/TSP-100/mc-Print3, Xprinter XP-R330H

***Specifications subject to change without notice, not responsible for typographical errors.**