

SPECIFICATION APPROVAL SHEET

7" (1024x600) Digital TFT LCD 500 nits, Aspect Ratio: 16:9, Input Signal HDMI 1.3a, Maximum Support Resolution 1920x1080, Headphone Driver, 46mW@32Ω, 5 Key Buttons Control, UART / RS232 Serial Remote Control (Option), 8 Language OSD Menu, LED Backlight, Single Operation Voltage +5V, Operating Temp -20 to 70C No cables, no accessories, no Power adapter.

MODEL: FCOPW0700HB



i-Tech Company LLC

TOLL FREE: (888) 483-2418 • EMAIL: info@itechlcd.com • WEB: www.iTechLCD.com

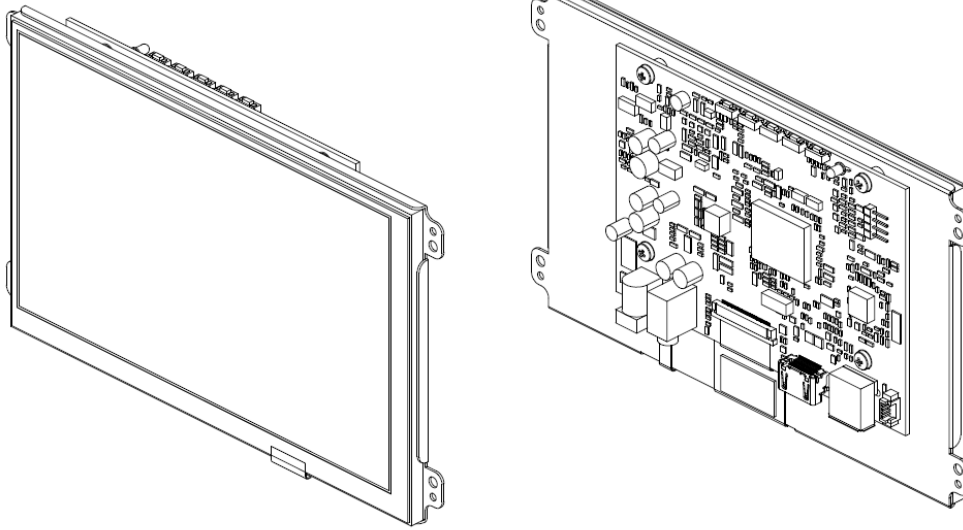

1. General Description

1.1 Features

- 7" (1024x600) Digital TFT LCD
- Aspect Ratio: 16:9
- Input Signal HDMI 1.3a
- Maximum Support Resolution 1920x1080
- Headphone Driver, 46mW@32Ω
- Touch Screen 4W Resistive
- 5 Key Buttons Control
- UART / RS232 Serial Remote Control (Option)
- 9 Language OSD Menu
- LED Backlight
- Single Operation Voltage +5V

1.2 Applications

- Industrial
- Medical Environment
- Instrument Display
- Kiosk
- Security
- Signage
- Office Electronics
- Home Application
- Educate Application



2. Contents

Contents	Page
1. General Description.....	1
1.1 Features	1
1.2 Applications	1
2. Contents.....	2-3
3. Specifications.....	4
4. Block Diagram.....	4
5. Order Information.....	5
5.1 Unit	5
5.2 Customized	5
6. Accessories (Option).....	6
7. Operation manual / Connection.....	7
7.1 Driver Board Manual	7
8. Pin Description.....	8-9
8.1 J101 : Pin Assignment of Power Input (DC-Jack Inside Diameter:2.5 φ Outside Diameter:5.5 φ Side Entry Type)	8
8.2 J702: Pin Assignment of UART (Pitch 1.25mm 4Pin, Top Entry Type)	8
8.3 J401 : Pin Assignment of HDMI-A Type Input (HDMI 1.3a -19Pin Female)	8
8.4 J601D : Pin Assignment of Key Board (Pitch 1.25mm 12Pin , Side Entry Type)	9
8.5 J701 : Pin Assignment of Touch USB (USB A Type - Female 2.0mm, Side Entry Type)(Option)	9
8.6 J301 : Pin Assignment of Phone Jack (Outside Diameter:3.5 φ Side Entry Type)	9
9. Absolute Maximum Ratings.....	10
9.1 Absolute Maximum Ratings	10
10. Recommended Operating Conditions.....	10
10.1 Electrical Characteristics	10
10.2 Support Display Mode Characteristics	10
11. 4W Resistive Touch Panel Characteristics.....	11-14
11.1 4W Electrical Performance	11
11.2 4W Optical Performance	11
11.3 4W Mechanical Performance	11
11.4 4W Durability Performance	11
11.5 Resistive Touch Panel Operation System Support	12
11.6 Resistive Touch Panel Integration Design Guide	13
11.7 Mechanical Design Notice For Resistive Touch Panel	14
12. Key Function by OSD.....	15-18
12.1 Menu Operation	15-18
13. Dimension Information.....	19-20
13.1 Unit (FCOPW0700HB)	19



13.2 Unit (FCOPW0700HB-TR)	20
14. Appendix.....	21
14.1 TFT-LCD Mechanical Specifications	21
14.2 TFT-LCD Optical Characteristics	21

3. Specifications

LCD	
Panel Size	7"
Resolution (Pixels)	1024x600
Color	262K
Luminance without RTP	500 cd/m ²
Luminance (RTP)	400 cd/m ²
Contrast Ratio	700
Viewing Angle	75(L) / 75(R) / 70(T) / 75(B)
LED Life Time (Typ.)	20K hours
Power Requirement	
Power Input (DC Jack 2.5 φ)	+5Vdc
Power Consumption	6.21 Watts
Touch Screen	
Resistive Type	USB Interface
Resistive Type Support OS	Windows / Linux / Mac / QNX

Input Signal		
HDMI	1.3a	
Audio		
Headphone Driver	46mW@32Ω Phone Jack φ 3.5	
Controls		
Key	5 Buttons	
Serial Remote Control	UART / RS232 (Option)	
Environment		
	Without RTP	4W RTP
Temperature Range	Operating	-20~+70 (Ts) °C
	Storage	-30~+80°C
High Temperature & High Humidity (Non-condensing)	Operating	+40°C / 90%
		+35°C / 90%

4. Block Diagram

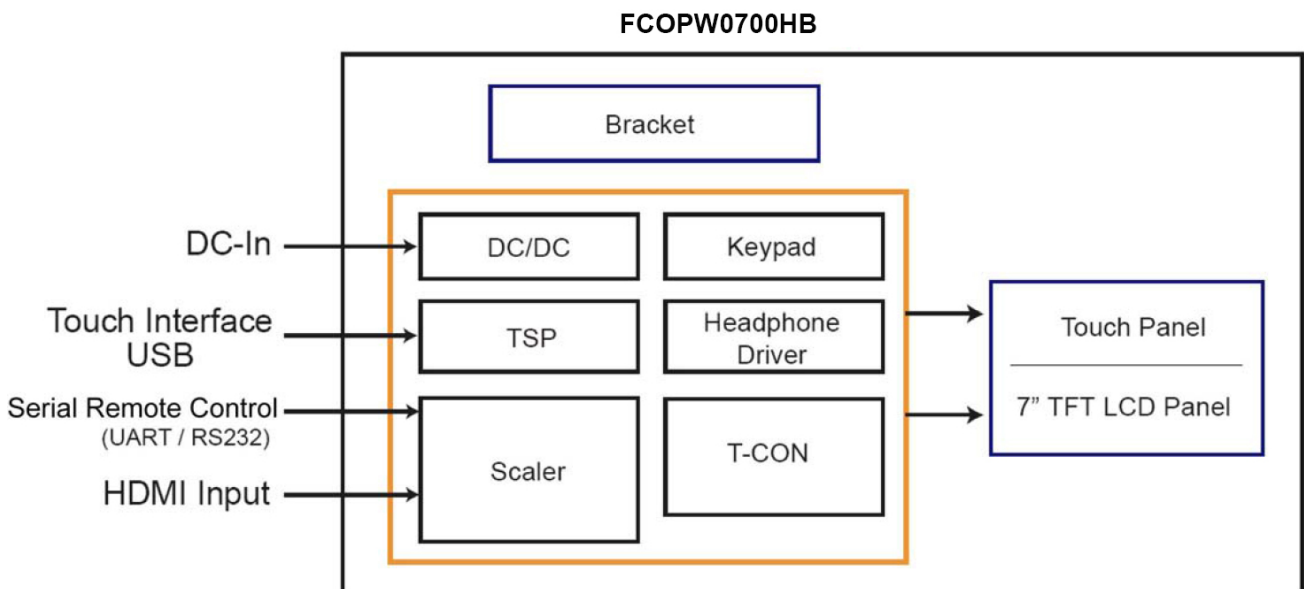



5. Order Information

5.1 *Unit*

Item	FCOPW0700HB	FCOPW0700HB-TR	Unit	Remark
HDMI	⊙	⊙		
Touch Panel Type	-	4W Resistive		
Touch Screen Interface	-	USB		
Headphone Driver	⊙	⊙		
5 Keys	⊙	⊙		
Serial Remote Control	UART	UART		
Dimension	180.5 x 107.2 x 24.5	180.5 x 107.2 x 26.3	mm	
Weight	395	432.5	g	±10%
Condition	Standard	Standard		

Note: 1. The assembling of panel and bracket is aimed for delivery, packaging and experiment. If the demand of shockproof and long-term fix, pls have it into consideration of mechanism design.

5.2 *Customized*

Function	Item
Serial Remote Control	RS232 (DB9)
External Key	5 keys

Note: Special order condition will apply to non-standard items and pls. contact salespersons in iTech.

6. Accessories (Option)

Before you begin installing the KIT, please make sure that the following materials have been shipped:

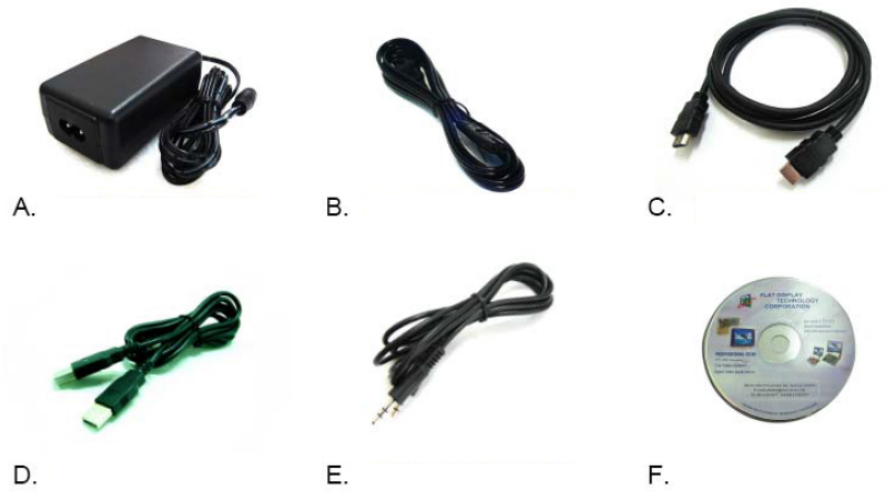

- A. AC to DC Adapter (L:1500mm,100-240V_{AC} 50-60Hz to +5V_{DC} @ 3A, ϕ 2.5)
- B. Power Cord (L:1800mm, Plug Type B for USA)
- C. HDMI Cable (L:1800mm)
- D. USB Cable (L:1800mm)
- E. AUDIO Cable (L:1800mm)
- F. Touch Screen Driver CD Disk / User Manual

7. Operation manual / Connection

7.1 Driver Board Manual

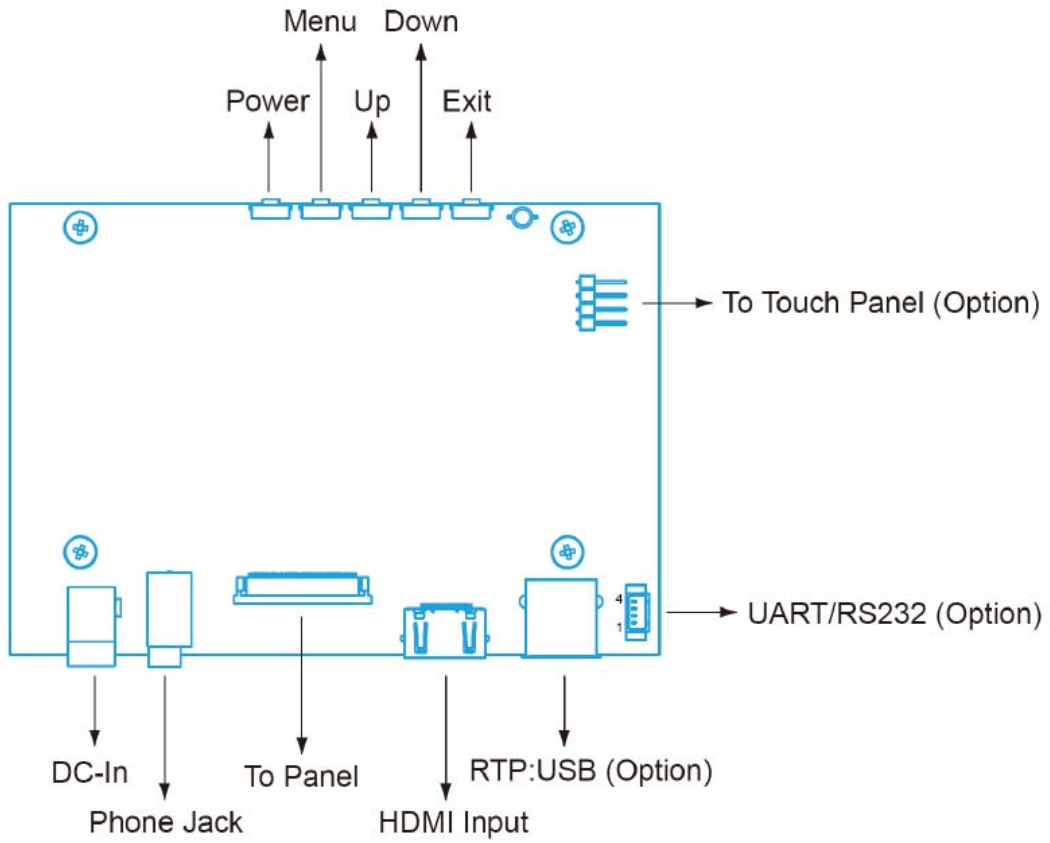

8. Pin Description

8.1 J101 : Pin Assignment of Power Input (DC Jack Inside Diameter:2.5 φ Outside Diameter:5.5 φ Side Entry Type)

Pin No.	Symbol	I/O	Description	Remark
1	DC-In	I	+5 Vdc Input Voltage	
2	GND	-	Power Ground	

8.2 J702 : Pin Assignment of UART (Pitch 1.25mm 4Pin, Top Entry Type)

※ Connector [Same as 53398-0471 (MOLEX)] ;

※ Matching Connector [Same as 51021-0400 (MOLEX)].

Pin No.	Symbol	I/O	Description	Remark
1	TX / RS232 TX (Option)	O	UART / RS232 (Option) Transmission Data	
2	RX / RS232 RX (Option)	I	UART / RS232 (Option) Receive Data	
3	GND	-	Ground	
4	+3.3Vdc	O	+3.3Vdc Output Voltage	

Note: All Functions can be controlled by UART , About UART command list please contact sales.

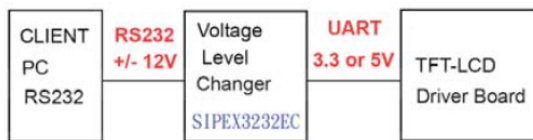

8.3 J401 : Pin Assignment of HDMI-A Type Input (HDMI 1.3a -19Pin Female)

Pin No.	Symbol	I/O	Description	Remark
1	DATA2+	I	Positive HDMI Input for B Link Data Channel 2	
2	DET_HDMI	-	HDMI Detect	
3	DATA2-	I	Negative HDMI Input for B Link Data Channel 2	
4	DATA1+	I	Positive HDMI Input for B Link Data Channel 1	
5	GND	-	Ground	
6	DATA1-	I	Negative HDMI Input for B Link Data Channel 1	
7	DATA0+	I	Positive HDMI Input for B Link Data Channel 0	
8	GND	-	Ground	
9	DATA0-	I	Negative HDMI Input for B Link Data Channel 0	
10	DCLK+	I	Positive HDMI Input for B Link Clock Channel	
11	GND	-	Ground	
12	DCLK-	I	Negative HDMI Input for B Link Clock Channel	
13	NC	-	No Connection	
14	NC	-	No Connection	
15	HDMI_SCL	I	DDC2 Clock	
16	HDMI_SDA	I	DDC2 Data	
17	GND	I	DDC/CEC Ground	
18	HDMI5V	I	HDMI +5Vdc Input	
19	HDMI_HPD	I	Hot Plug Detect	

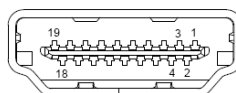

8.4 J601D : Pin Assignment of Key Board (Pitch 1.25mm 12Pin , Side Entry Type)(Option)

※ Connector [Same as 53261-1219 (MOLEX)] ;

※ Matching Connector [Same as 51021-1200 (MOLEX)].

Pin No.	Symbol	I/O	Description	Remark
1	-	-	Don't Connect	
2	SW5	I	EXIT	
3	SW4	I	DOWN	
4	SW3	I	UP	
5	SW2	I	MENU / S	
6	SW1	I	POWER / SOURCE	
7	GND	-	Ground	
8	VDDP	-	VDDP +3.3Vdc Output Voltage	
9	-	-	Don't Connect	
10	RED	O	Indicator red LED for power off control	
11	GREEN	O	Indicator green LED for power on control	
12	GND	-	Ground	

8.5 J701 : Pin Assignment of Touch USB (USB A Type - Female 2.0mm, Side Entry Type)(Option)

Pin No.	Symbol	I/O	Description	Remark
1	VBUS	-	USB VCC	
2	D-	-	DATA (-)	
3	D+	-	DATA (+)	
4	DGND	-	Digital Ground	

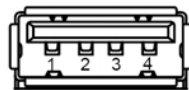

8.6 J301 : Pin Assignment of Phone Jack (Outside Diameter:3.5 φSide Entry Type)

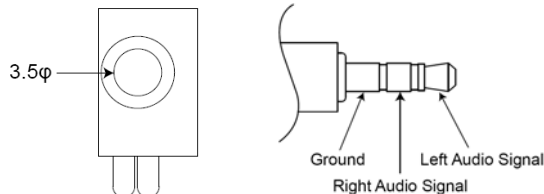



9. Absolute Maximum Ratings

9.1 Absolute Maximum Ratings

Parameter	Symbol	Min	Max	Unit	Remark
Input Voltage	V _{in}	+4.2	+6	V	
Digital Input Signal	TTL	0.3	3.6	V	
HDMI Input Signal		-	165	MHz	
Operating Temp. without RTP		-20	+70	°C	
Storage Temp. without RTP		-30	+80	°C	
Operating Temp. 4W RTP		-20	+70	°C	
Storage Temp. 4W RTP		-30	+80	°C	
High Temperature & High Humidity (Non-condensing) without RTP		-	+40 / 90	°C / %	
High Temperature & High Humidity (Non-condensing) 4W RTP		-	+35 / 90	°C / %	

10. Recommended Operating Conditions

10.1 Electrical Characteristics

Parameter	Symbol	I/O	Min	Typ	Max	Unit	Note
Input Voltage	DC-in	I	+4.7	+5	+5.8	V	
Total Current	I-in	I	-	824	-	mA	+5V
Power Consumption		I	-	4.12	-	W	±15%
Output Voltage	VDD	O	3.2	3.3	3.4	V	
HDMI Input Signal			-	165	-	MHz	

10.2 Support Display Mode Characteristics

Dots per inch	H	Unit	V	Unit	Note
800 × 600	37.9	KHz	60.3	Hz	
1024 × 600	37.5	KHz	60	Hz	
1024 × 768	48.4	KHz	60	Hz	
1280 × 1024	64	KHz	60	Hz	
1600 × 1200	75	KHz	60	Hz	
1920 × 1080	67.5	KHz	60	Hz	



11. 4W Resistive Touch Panel Characteristics

11.1 4W Electrical Performance

Parameter	Symbol	Min	Typ	Max	Unit	Note
Terminal Resistance	X	20	-	500	Ω	
	Y	20	-	500	Ω	
Linearity		-	-	1.5	%	
Insulation Impedance		20	-	-	M Ω	DC 25V
Response Time		-	-	20	ms	

11.2 4W Optical Performance

Parameter	Specifications
Light Transmittance	>80% \pm 5%
Haze	< 10%

11.3 4W Mechanical Performance

Parameter	Specifications
Input Method	Stylus or Finger
Operating Force	100g, R8 Silicon Rubber, 60HS
Surface Hardness	3H pencil, pressure 1N/45°

11.4 4W Durability Performance

Parameter	Specifications
Knock Test	1,000,000 times, Weight \leq 100g. 2 times/sec (Tip R8 mm Silicone rubber)
Pen Sliding Test	100,000 times, Weight \leq 100g. 30 times/sec (Tip R0.8 mm Stylus pen)



11.5 Resistive Touch Panel Operation System Support

Driver Vender : EETI (eGalax_eMPIA Technology Inc.)

OS	Version	Interface
Windows	Windows 7, 8, 8.1, 10	USB/RS232
	Windows Embedded 7, 8	
	Windows Embedded POSReady 2009, POSReady 7	
	Embedded Standard 7	
	Embedded Enterprise 7	
	Embedded 8 Standard	
	Embedded 8.1 Pro/ Embedded 8.1 Industry	
	Windows , XP, 2000	
Windows XP Embedded		
Windows CE	Windows Embedded Compact 2013,7	USB/RS232
	Windows CE 6.0	
	Windows CE.Net (4.x / 5.0)	
Linux	Kernel 2.6.24 Upward and 3.x.x / 4.x.x / 5.x.x (X86 / ARM / MIPS)	USB
	Kernel 2.6.23 Downward (X86)	
	Kernel 2.4.x (x86)	
Android	Android Version 2.3.x upwards (X86 / ARM / MIPS)	USB
Mac OS	Mac OS X 10.5.3 Leopard (Power PC)	USB
	Mac OS X 10.7.4 Earlier (32Bit / 64Bit) (Intel CPU)	
	Mac OS X 10.7.5 (32Bit / 64Bit) (Intel CPU)	
	Mac OS X 10.8.x Mountain Lion (Intel CPU)	
	Mac OS X 10.9.x Mavericks (Intel CPU)	
	Mac OS X 10.10.x Yosemite (Intel CPU)	
	Mac OS X 10.11 El Capitan (Intel CPU)	
	Mac OS 10.12 Sierra (Intel CPU)	
	Mac OS 10.13 High Sierra (Intel CPU)	
	Mac OS 10.14 Mojave (Intel CPU)	
	Mac OS 10.15 Catalina (Intel CPU)	
QNX	QNX Neutrino RTOS V6.5/6.4	USB/RS232
	QNX Neutrino RTOS V6.3	

Note: 1. Please refer to the iTech website for the driver installation and support operating system.

Website: ww.ittechlcd.com

2. How to use Touch Driver, please refer to Readme of Touch Screen Driver CD Disk.

3. Please refer to the iTech website for the latest driver version and support operating system.

11.6 Resistive Touch Panel Integration Design Guide

Front case design follow as below

- 1. Avoid the design that front case overlap and press on the active area of the LCM.
- 2. Give enough gap(over 0.5mm at compressed) between the front case and TSP to protect wrong operating.

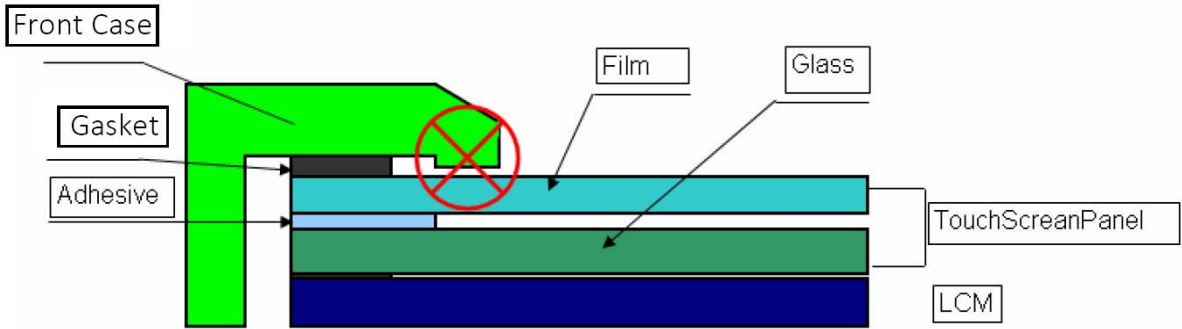

- 3. Use a buffer material(Gasket) between the TSP and front case to protect damage and wrong operating.
- 4. Avoid the design that buffer material overlap and press on the inside of TSP view area.

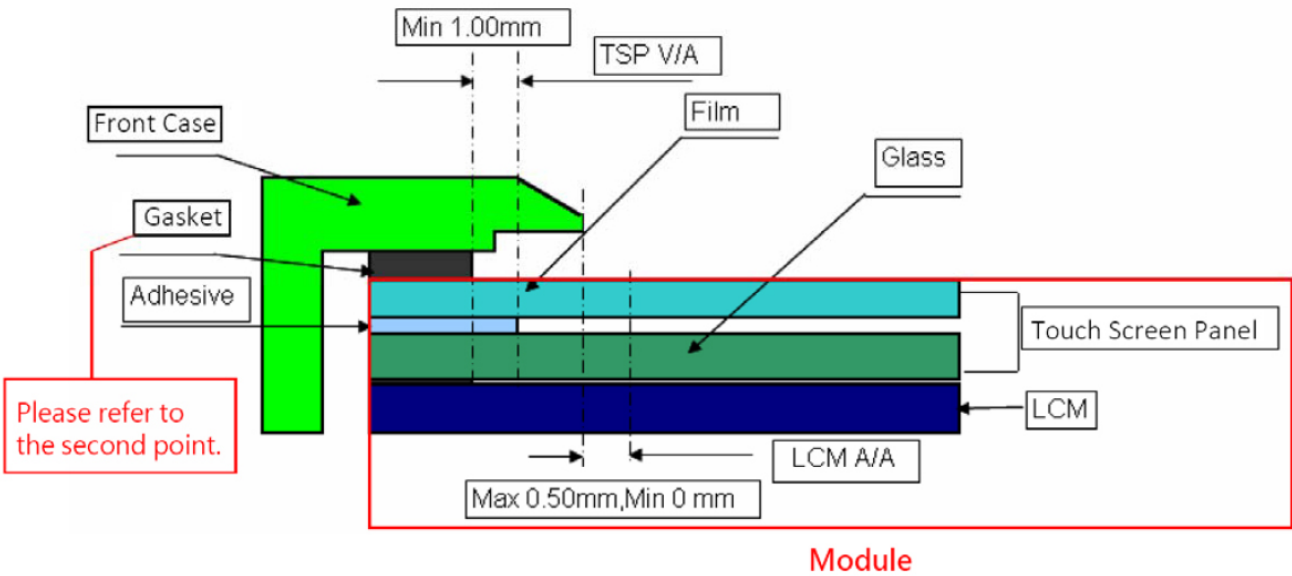

11.7 Mechanical Design Notice For Resistive Touch Panel

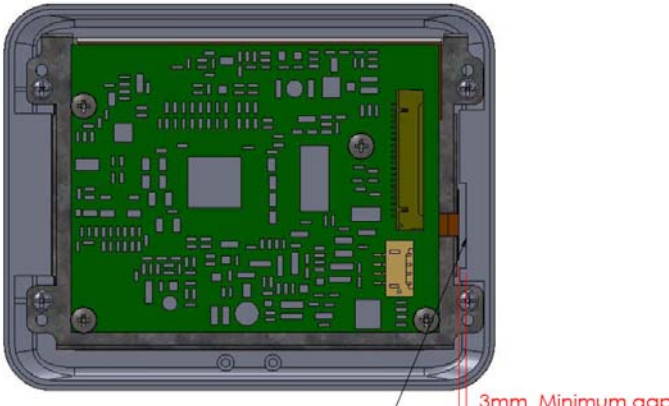
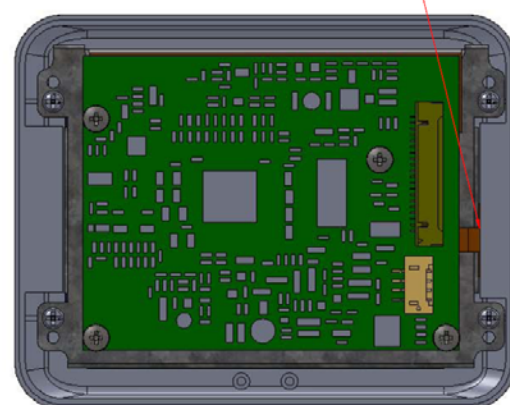
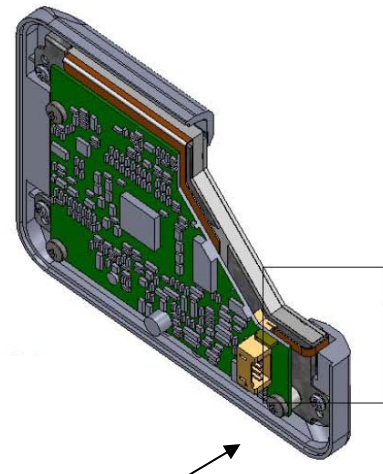
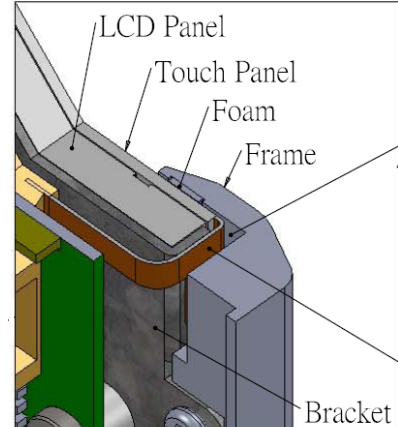
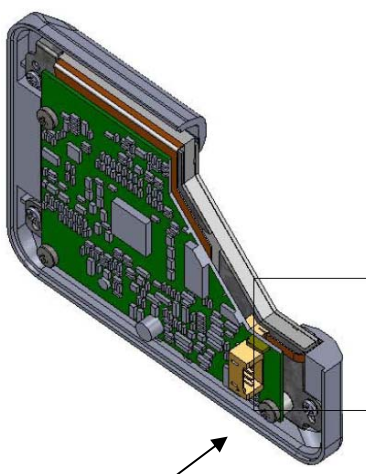
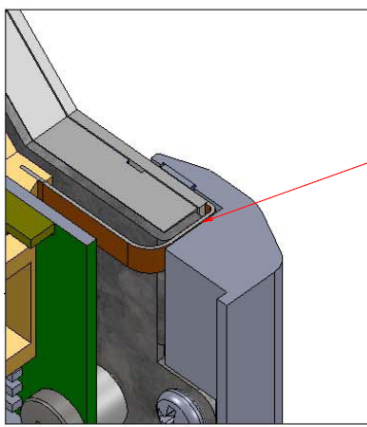
Correct Installation	Incorrect Installation
 <p data-bbox="159 795 478 840"><Correct Installation></p> <p data-bbox="558 761 766 795">3mm Minimum gap</p>	 <p data-bbox="957 369 1308 414"><Incorrect Installation></p>
 <p data-bbox="399 1400 766 1444"><Correct Installation></p>  <p data-bbox="223 1892 319 1926">Zoom-In</p> <p data-bbox="159 1467 399 1859"> LCD Panel Touch Panel Foam Frame FPC to Touch Panel Bracket </p> <p data-bbox="478 1624 782 1724"> ! Frame can not surpress on LCD Panel and FPC to Touch Panel </p>	 <p data-bbox="1117 1411 1500 1456"><Incorrect Installation></p>  <p data-bbox="957 1881 1053 1915">Zoom-In</p> <p data-bbox="1197 1646 1484 1747"> ! Supression on FPC to Touch Panel causes the fracture. </p>

12. Key Function by OSD

12.1 Menu Operation

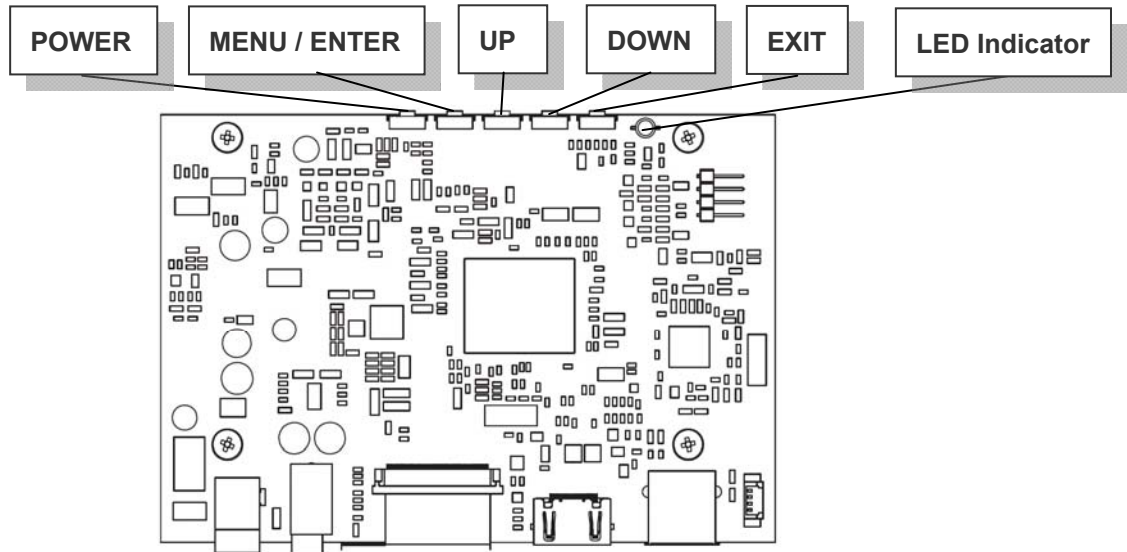

OSD ICON Instructions :

1. POWER : Power On/Off
2. MENU / ENTER : (After turning on MENU, only ENTER is available)
3. UP : Move Upward / Increase Value / Option Switch
4. DOWN : Move Downward / Decrease Value / Option Switch
5. EXIT : Return to Previous Page
6. LED Indicator
 - 6.1 Waiting : Flickering Green
 - 6.2 Power ON : Green
 - 6.3 Power OFF : Red

Save OSD Setting:



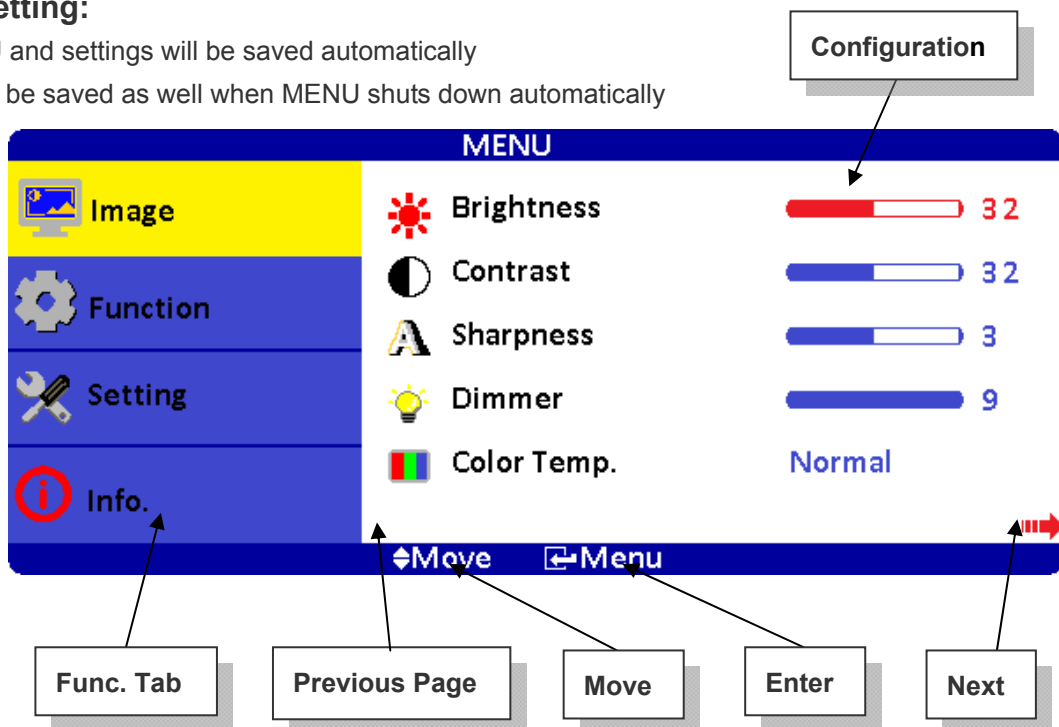



1. EXIT MENU and settings will be saved automatically
2. Settings will be saved as well when MENU shuts down automatically



Overview of the Menu :









Image

Indicator	Meaning	Default	Adjustable range	Remark
	Brightness	32	0~63	Adjust-Bar
	Contrast	32	0~63	Adjust-Bar
	Sharpness	3	1~5	Adjust-Bar
	Dimmer	15	0~15	Adjust-Bar
	Color Temp.	Normal	Normal / Warm / Cool	
	Exit			



Function

ICON	Meaning	Function	Default	Status	Description	Remark
	Show Status	Information of input source	On	On	Show input source	
				Off	Hide input source	
	Blue Screen	Select blue/ black screen when no input signal is detected.	On	On	Show blue screen when no input.	
				Off	Show black screen when no input.	
	Auto Power On	Modules turns on automatically without power key input.	On	On	Auto	
				Off	Manual	
				Auto Save	Power off , the last state	
	Auto Power Saving	Modules go standby when no input source is detected.	Off	6s / 15s / 30s	Go standby by settings when no input	LED indicator: Flickering Green
				Off	Show no signal when no input	LED indicator: Green
	Auto Sleep	Modules go off when set timing is out.	Off	15M / 30M / 60M	Go off by time setting	LED indicator: Red Press Power Key back to life.
				Off	Turn off sleep mode	
	Exit					

Note : After configuration is set, RESET won't restore to default setting.

Setting

Indicator	Meaning	Default	Adjustable range	Remark
	Volume	32	0~63	
	Mute	Off	On / Off	On : Mute · Off : Sound
	Mirror	Off	On / Off	Left-right reversal
	Flip	Off	On / Off	Upside down
	Language	English	English / 中文 / 日本語 / 한국의 / Française / Deutsch / Italiano / Española / Português	Reset won't restore to default setting
	Reset			Restore to default
	Exit			

Info.

MENU

Image	Source : HDMI
Function	Resolution : 1024x600
Setting	H-Position : 37.5KHz V-Position : 59.8Hz
Information	Program Ver : 1.00 Command Ver : 1.00

⇐ Move ⇐ Exit / Menu

Hot Key When OSD Menu is Off :

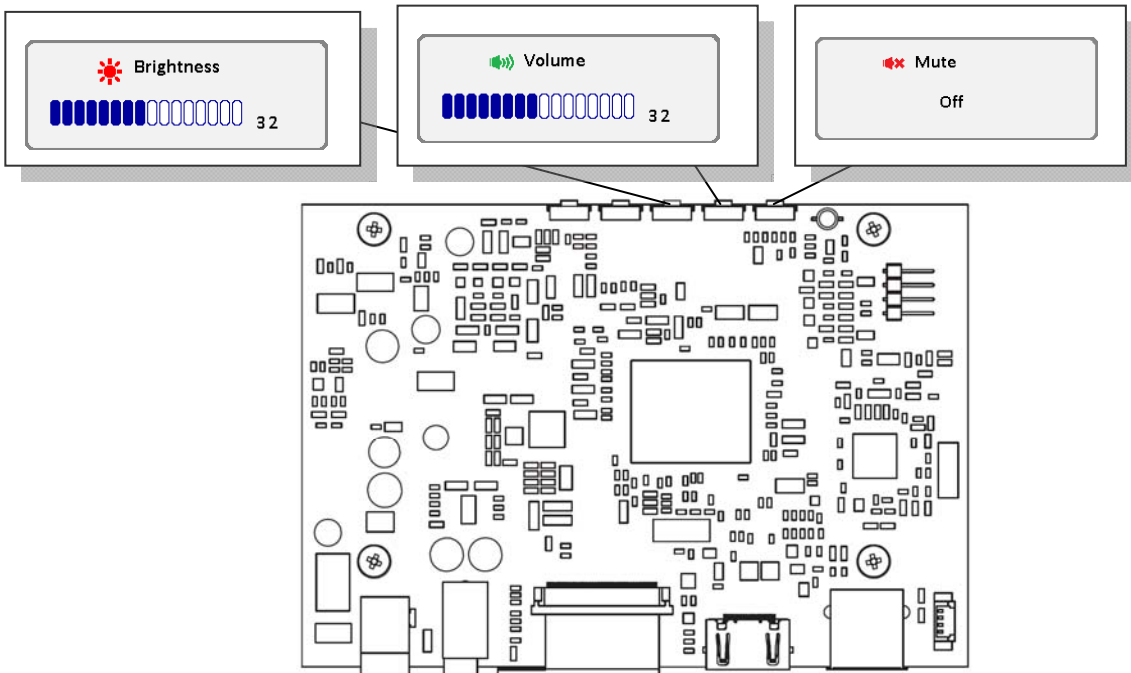

Information of Input Source and Functionality :

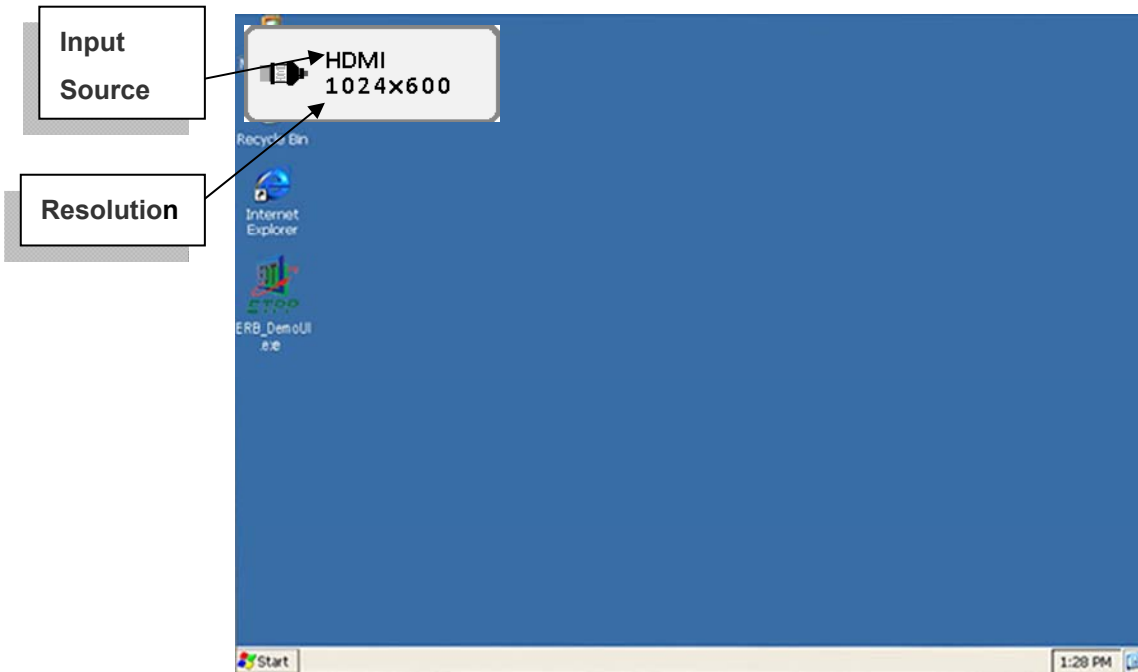

[Source] : Input Signal Switch

Overview of Input Signals :

Indicator	Interface
	HDMI



13. Dimension Information

13.1 Unit (FCOPW0700HB)

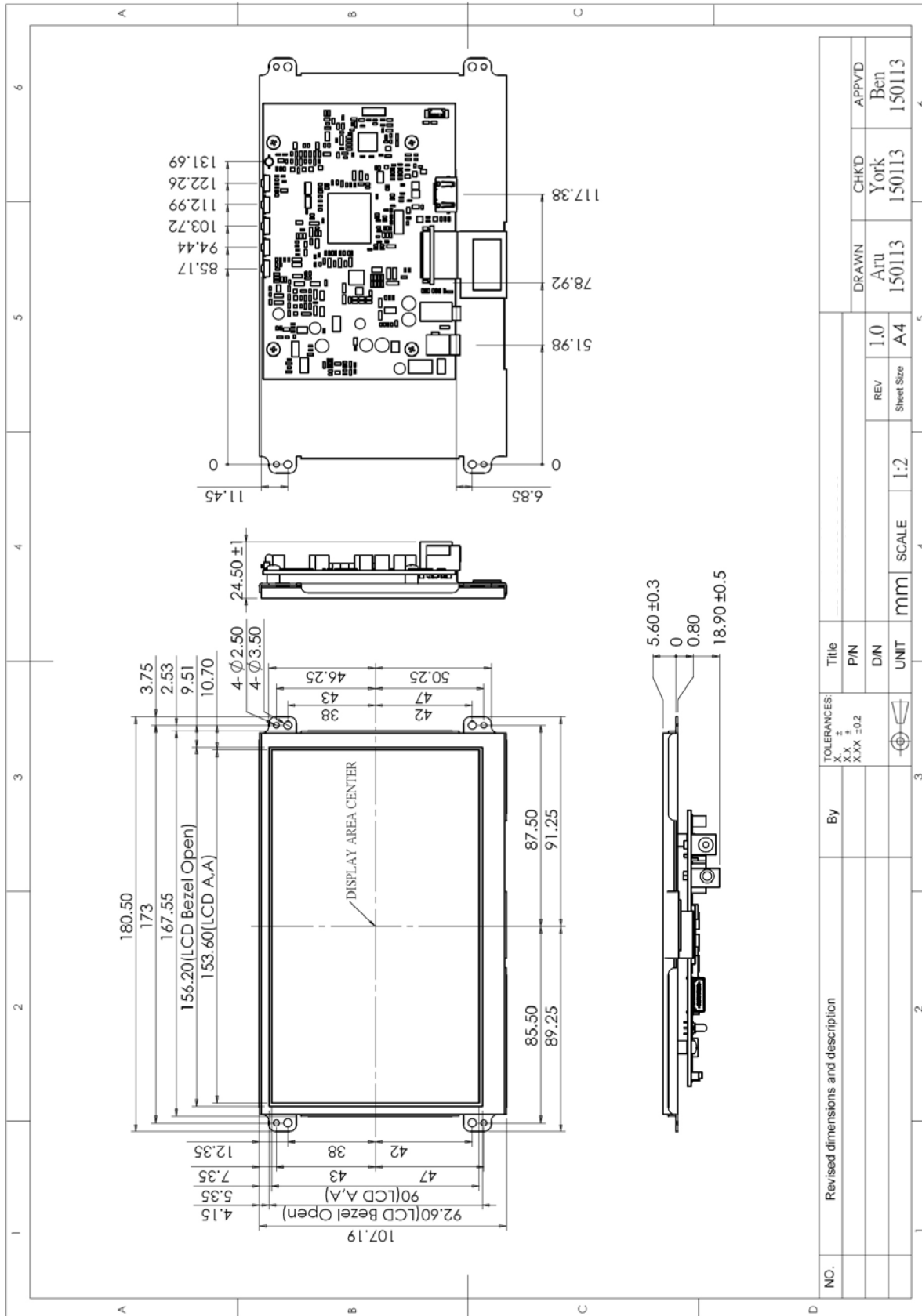

13.2 Unit (FCOPW0700HB-TR)

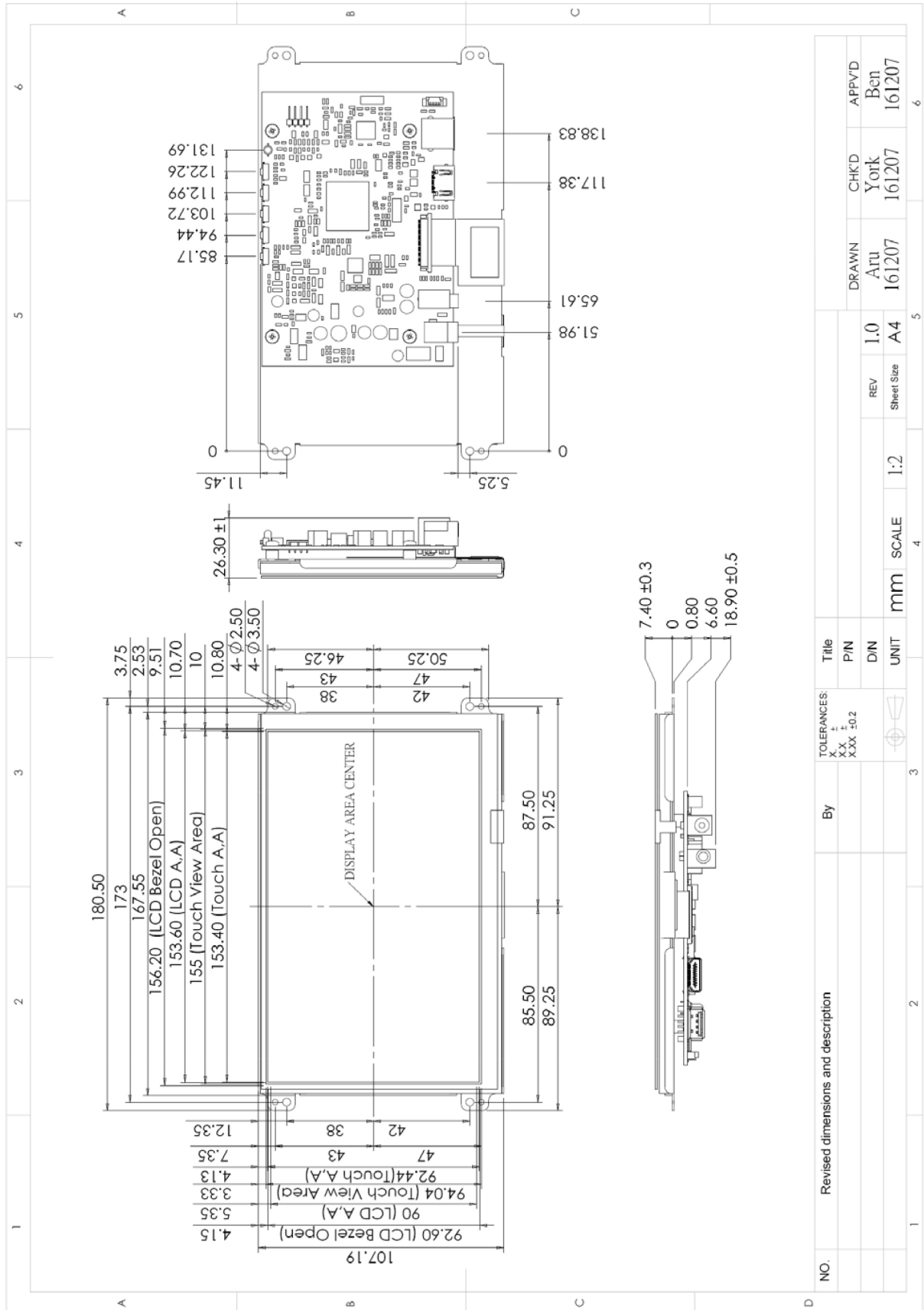



14. Appendix

14.1 TFT-LCD Mechanical Specifications

Parameter	Specifications	Unit
Screen Size	7 (diagonal)	Inch
Display Format	1024 x (R.G.B) x 600	Dot
Active Area	153.6(W) × 90.0(H)	mm
Pixel Pitch	0.15(H) x 0.15(V)	mm
Pixel Arrangement	RGB-stripe	
Surface Treatment	Clear	

14.2 TFT-LCD Optical Characteristics

Parameter	Symbol	Condition	Min	Typ	Max	Unit	Remark
Viewing Angle	Horizontal	Left	CR ≥ 10	65	75	---	deg
		Right		65	75	---	deg
	Vertical	Top		60	70	---	deg
		Bottom		65	75	---	deg
Contrast Ratio	CR	At optimized Viewing angle	500	700	---	---	
Luminance without RTP	L		400	500	---	cd/m ²	
LED Life Time		25°C	---	20000	---	hours	Note

Note: The "LED Life Time" is defined as the module brightness decrease to 50% original.