

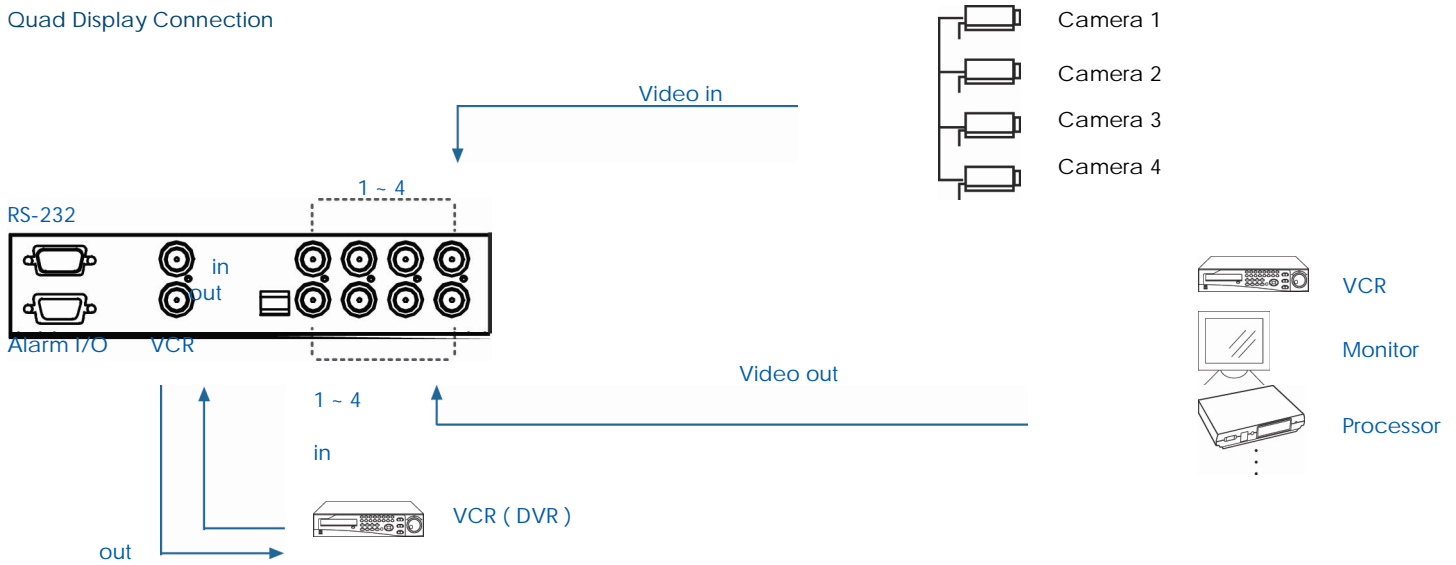

Netview Series

Dedicated KVM Switch and
Rackmount LCD Technology

Quad Display Connection



Front QD membrane button



- On-screen menu setup in Quad mode
- LCD on-screen menu setup

Specifications

Item		Description	
Model Number		QD (NTSC)	QD (PAL)
Number of Colour		16.7 Mil.	16.7 Mil.
Imaging System		NTSC	PAL
Resolution		1024 x 525	1024 x 625
Refresh Rate		60	50
Video Input	Camera Input	1.0Vpp, 75 Ohm x 4	
	VCR Input	1.0Vpp, 75 Ohm x 1	
Video Output	Live Monitor	1.0Vpp, 75 Ohm x 1	
	Loop Through Out	1.0Vpp, 75 Ohm x 4	
	VCR Output	1.0Vpp, 75 Ohm x 1	
Auto Gain Control		Yes	
Time / Date		Yes	
On Screen Display		Yes	
Camera Title		8 Character Title	
Display Format	2 x Zoom On Playback	Yes	
	QUAD	Yes	
	FULL	Yes	
	SEQUENCY	Yes	
Dwell Time		0 to 99 Sec Adjustable	
Built-in Buzzer		Yes	
Key Lock		Yes	



LCD Specifications

4 : 3 Screen size	15"	17"	19"	20"
Display type	Active Matrix TFT	Active Matrix TFT	Active Matrix TFT	Active Matrix TFT
Native resolution	1024 x 768	1280 x 1024	1280 x 1024	1600 x 1200
Brightness (cd/m ²)	250	300	300	300
Contrast ratio	700 : 1	1000 : 1	1000 : 1	800 : 1
Viewing angle (H x V)	150 / 135	160 / 160	160 / 160	160 / 160
Display colour	16.2M	16.7M	16.7M	16.7M
Response time	Tr=2 / Tf=6	Tr=1.3 / Tf=3.7	Tr=1.3 / Tf=3.7	Tr=1 / Tf=4
Pixel Pitch (mm)	0.297 x 0.297	0.264 x 0.264	0.294 x 0.294	0.255 x 0.255

WideScreen size	W19"	W22"
Display type	Active Matrix TFT	Active Matrix TFT
Native resolution	1440 x 900	1680 x 1050
Brightness (cd/m ²)	300	300
Contrast ratio	1000 : 1	1000 : 1
Viewing angle (H x V)	160 / 160	170 / 160
Display colour	16.7M	16.7M
Response time	Tr=1.3 / Tf=3.7	Tr=3.6 / Tf=1.4
Pixel Pitch (mm)	0.284 x 0.284	0.282 x 0.282



High Brightness LCD Specifications

4 : 3 Screen size	15"	17"	W19"	W22"
Display type	Active Matrix TFT	Active Matrix TFT	Active Matrix TFT	Active Matrix TFT
Native resolution	1280 x 1024	1280 x 1024	1440 x 900	1680 x 1050
Brightness (cd/m ²)	800	800	800	600
Contrast ratio	800 : 1	800 : 1	900 : 1	900 : 1
Viewing angle (H x V)	170 / 160	160 / 160	160 / 160	170 / 160
Display colour	16.7M	16.7M	16.7M	16.7M
Response time	Tr=3.5 / Tf=1.5	Tr=1.3 / Tf=3.7	Tr=1.3 / Tf=3.7	Tr=3.6 / Tf=1.4
Pixel Pitch (mm)	0.264 x 0.264	0.294 x 0.294	0.284 x 0.284	0.282 x 0.282

Ne



N keyboard integrated with touchpad

- 104 keys (US / European / Chinese / Korean layout)
- 106 keys (Japanese layout)
- PS/2 or USB connection



Dimensions Keyboard 395 x 156 x 15 (mm)
(W x L x H) Touchpad 107 x 82 x 15 (mm)

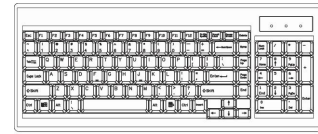

Nb



N keyboard integrated with trackball

- 104 keys (US / European / Chinese / Korean layout)
- 106 keys (Japanese layout)
- PS/2 or USB connection



Dimensions Keyboard 395 x 156 x 15 (mm)
(W x L x H) Trackball 107 x 82 x 18 (mm)

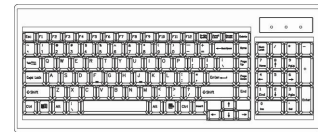

Se



NS keyboard integrated with touchpad

- Incorporates SUN keys, including Stop, Cut, Paste, Compose, Copy and Help
- 104 keys (US / UK layout)
- USB connection  

Dimensions Keyboard 395 x 156 x 15 (mm)
(W x L x H) Touchpad 107 x 82 x 15 (mm)

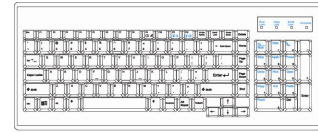

Sb



NS keyboard integrated with trackball

- Incorporates SUN keys, including Stop, Cut, Paste, Compose, Copy and Help
- 104 keys (US / UK layout)
- USB connection  

Dimensions Keyboard 395 x 156 x 15 (mm)
(W x L x H) Trackball 107 x 82 x 18 (mm)

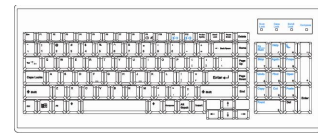

d



Compact keyboard with trackball

- Integrated 19mm trackball plus 3 mouse key
- Cursor key & numeric keys included
- 95 keys (US layout only)
- PS/2 or USB connection 

Dimensions 412 x 175 x 38 (mm)

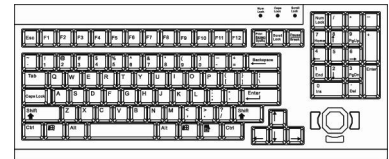

t



Compact keyboard with touchpad

- Integrated GlidePoint™ touchpad
- Cursor key & numeric keys included
- 95 keys (US layout only)
- PS/2 USB connection 

Dimensions 412 x 195 x 38 (mm)

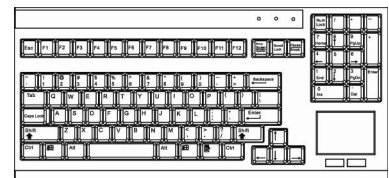

Coverage: **NX117** series, **NW119** series, **NVP117** series, **NVP217** series

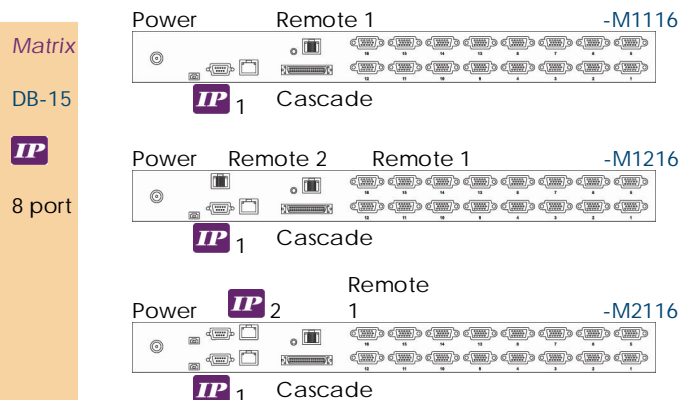
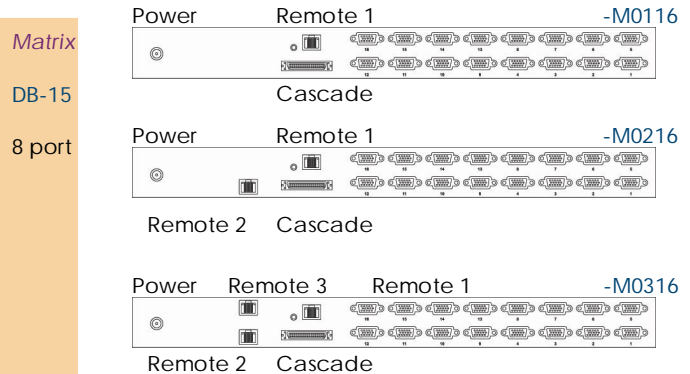
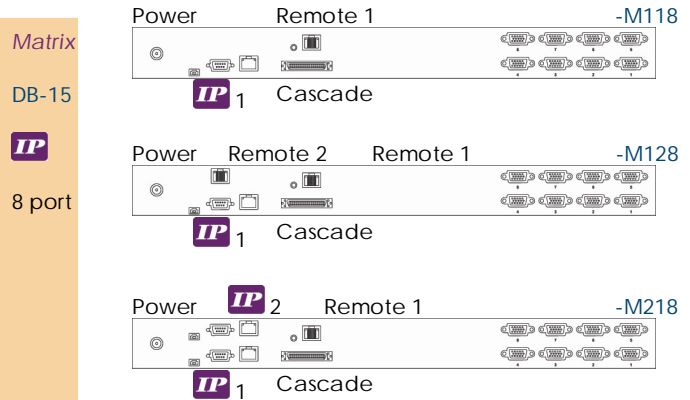
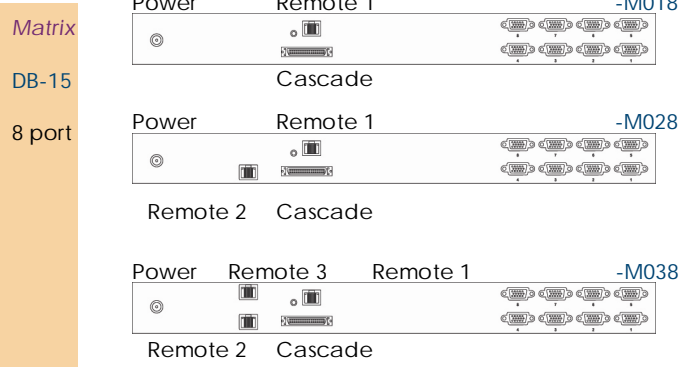
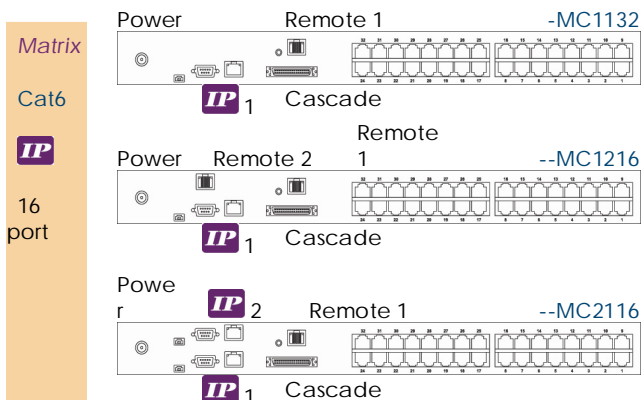
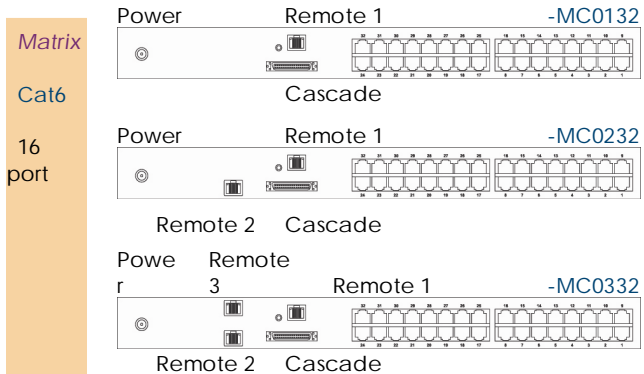
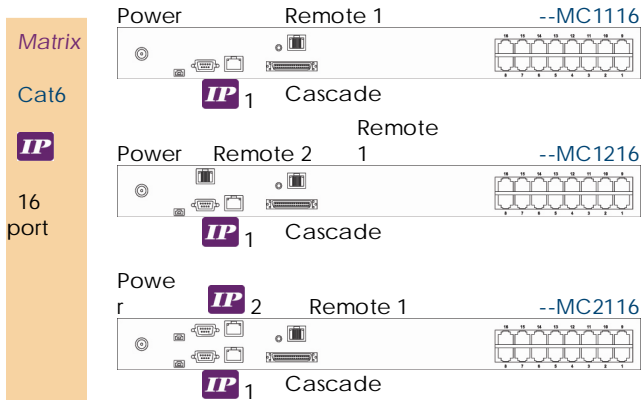
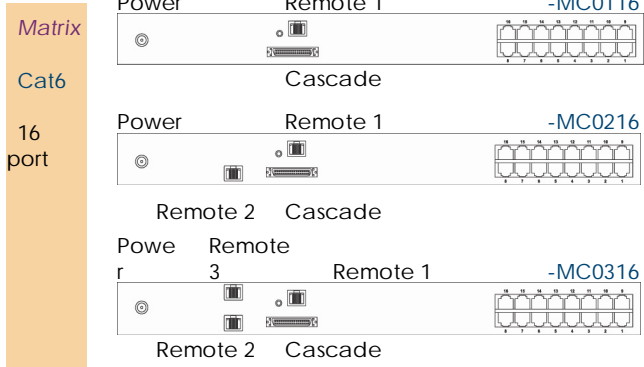

Coverage: **NX117** series, **NW119** series, **NVP117** series, **NVP217** series

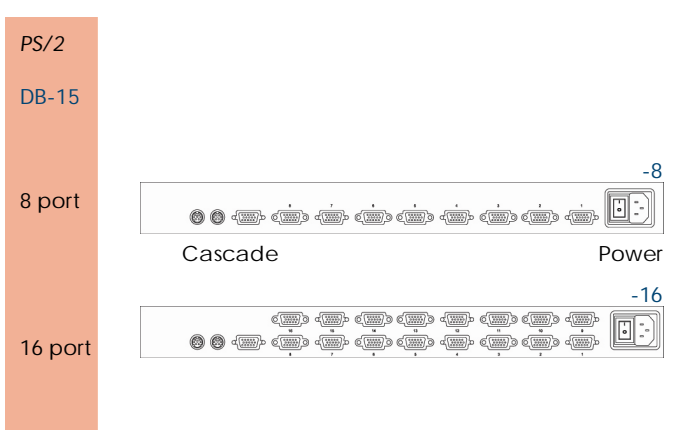
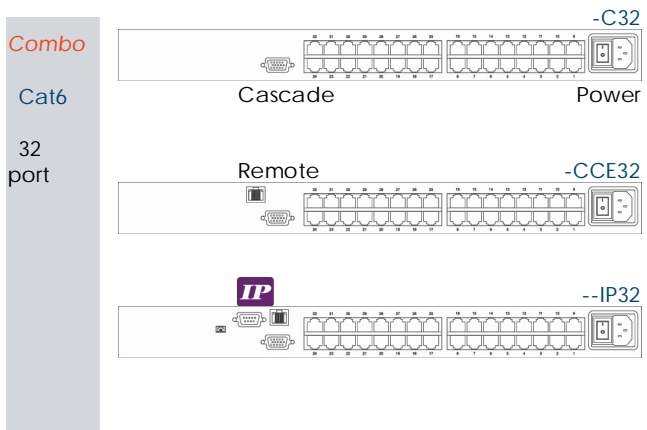
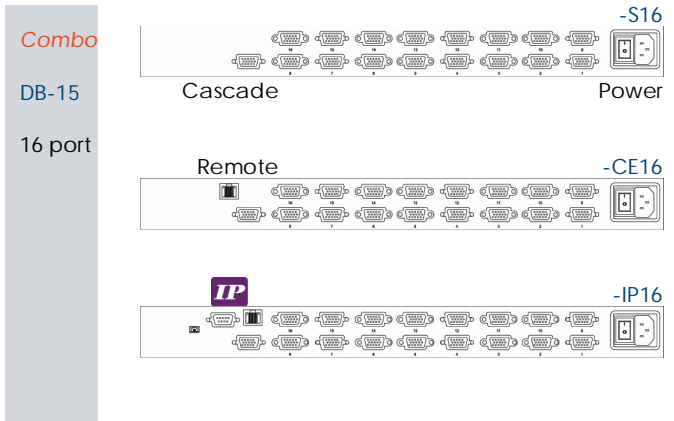
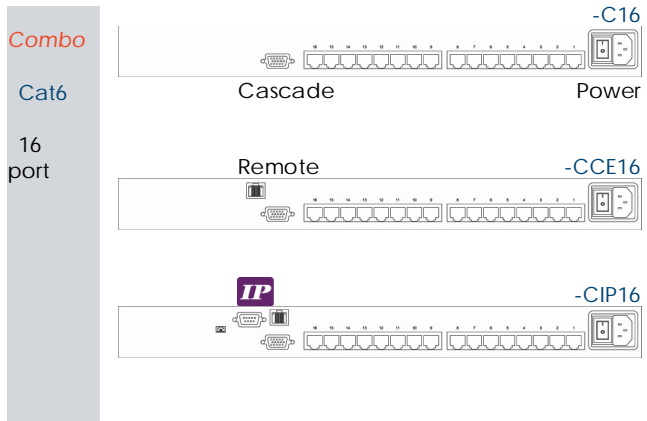
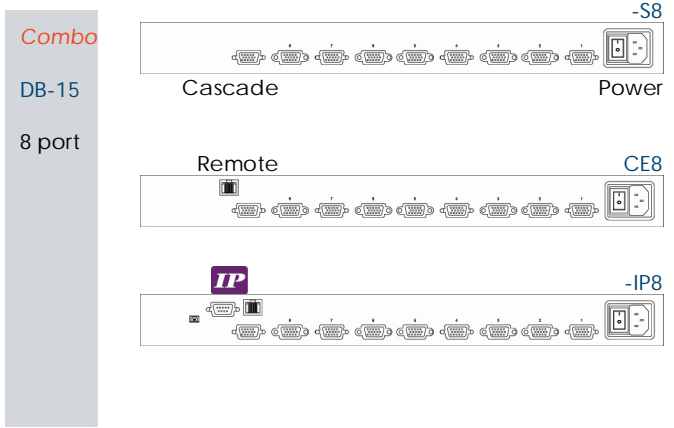
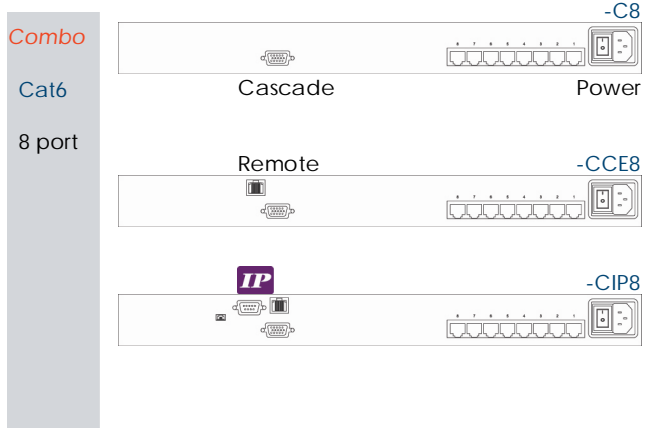

Coverage: [NVP120 series](#), [DR117 series](#), [NVP700 series](#), [NVP2415 series](#)

Matrix
Cat6
16 port

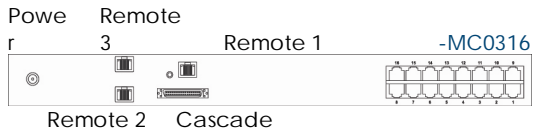
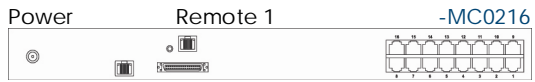
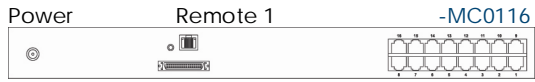

Matrix
Cat6
IP
16 port

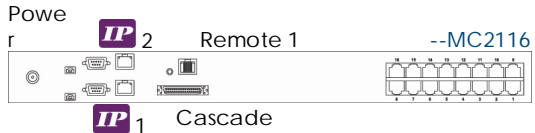
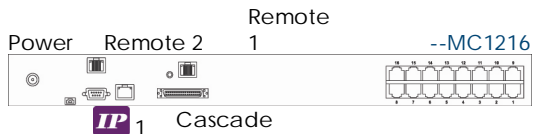
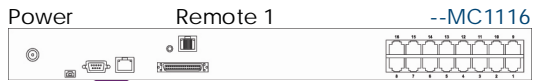

Matrix
Cat6
16 port

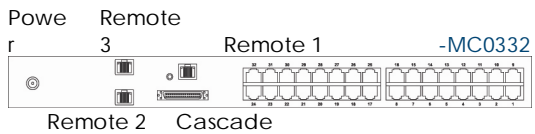
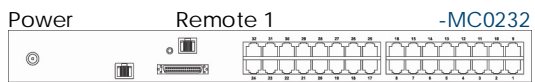
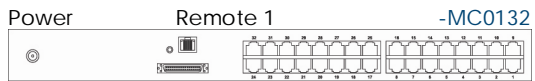

Matrix
Cat6
IP
16 port

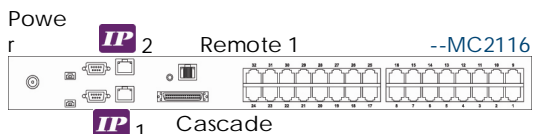
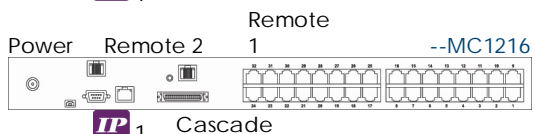
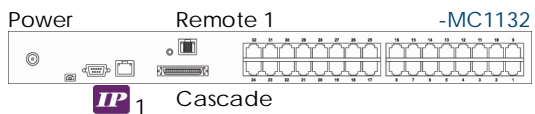

Matrix
DB-15
8 port

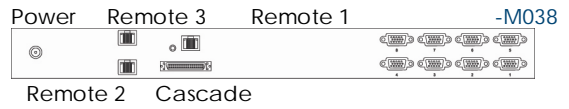
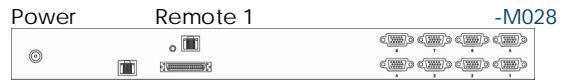
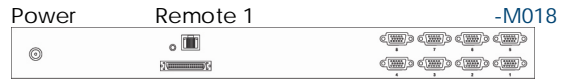

Matrix
DB-15
IP
8 port

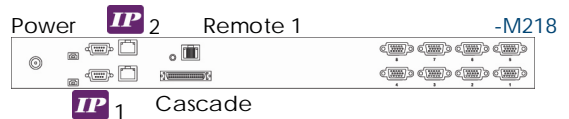
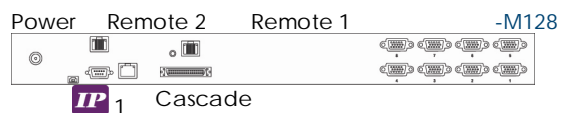
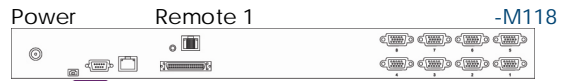

Matrix
DB-15
8 port

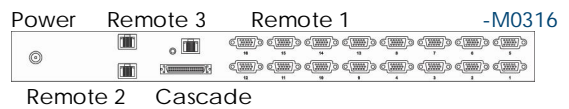
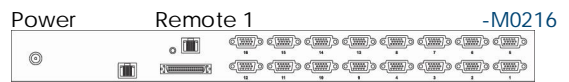
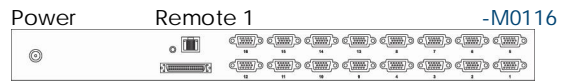

Matrix
DB-15
IP
8 port

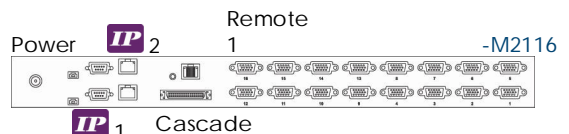
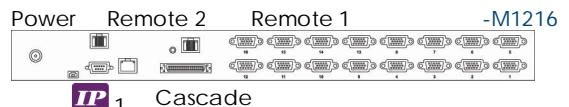
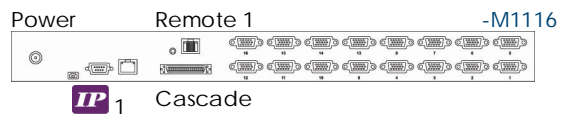

Coverage: NVP120 series, DR117 series, NVP700 series, H117 series, NVP2415 series

